



Ancon[®] Fixing Solutions for the Construction Industry

Ancon[®]

BUILDING PRODUCTS

Introduction to Ancon

Ancon designs and manufactures high integrity steel products for the construction industry, supplying customers worldwide in a variety of sectors from small-scale residential developments to major infrastructure projects.

Ancon's origins date back to 1882 when 'George Clark' was founded in Sheffield, England. The Ancon name came from 'Ancon Stainless Steel Fixings', which was founded in 1971 and merged with George Clark in 1993.

The company's 72,000ft² head office and main manufacturing site is still located in the city of Sheffield, world renowned as the traditional centre of the stainless steel industry. Today, Ancon has 350 employees at three UK manufacturing sites and eight overseas operations located in Australia, United Arab Emirates, Germany, Switzerland and Austria.

Ancon's UK sites are capable of producing a high volume of standard products on very short lead times, and bespoke products specifically engineered to meet individual project requirements.

On a daily basis, Ancon's technical staff liaise with project teams throughout the world, advising on the most cost-effective and practical construction solutions.

The company's impressive project portfolio includes:

- London St. Pancras Station, UK
- Ferrari World, Abu Dhabi
- Brisbane Airport Link Road, Australia
- Thessaloniki Metro, Greece
- Stade de Suisse, Switzerland

For more information on Ancon's products and services please email info@ancon.co.uk, call +44 (0) 114 275 5224 or visit:

www.ancon.co.uk

 www.anconbp.de

 www.ancon.ch

 www.ancon.at

 www.ancon.ae

 www.ancon.com.au

Ancon's management systems comply with ISO 9001, ISO 14001 and OHSAS 18001



ISO 9001: 2008
FM 12226



ISO 14001: 2004
EMS 505377



OHSAS 18001: 2007
OHS 548992



Ancon Head Office, Sheffield, South Yorkshire, UK



Deeside Manufacturing Facility, North Wales, UK



Laser Cutting Plate



Wire/Coil Machining



Corporate Social Responsibility

Ancon is committed to ethically and responsibly managing all aspects of its operations. Read exactly what this means in practice by requesting a copy of Ancon's CSR report.



Products for Brick, Block & Stone

pages

4-6

- Support Systems
- Lintels
- Windposts & Parapet Posts
- Masonry Reinforcement
- Channel & Bolt Fixings
- Wall Ties & Restraint Fixings



Architectural Metalwork

page

7

- Tension Systems
- Compression Systems



Products for Structural Concrete

pages

8-10

- Shear Load Connectors
- Punching Shear Reinforcement
- Reinforcing Bar Couplers
- Reinforcement Continuity Systems
- Thermal Breaks
- Stainless Steel Reinforcement
- Corner Guards



Additional Stainless Steel Solutions

page

11

- Special Fabrications
- Flooring
- Formed Sections

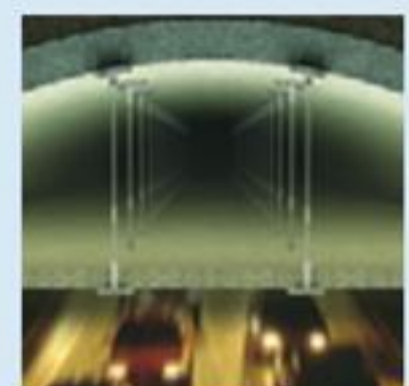

Products for Brick, Block & Stone



AnconOptima Masonry Support
Patent No. EP 1211364

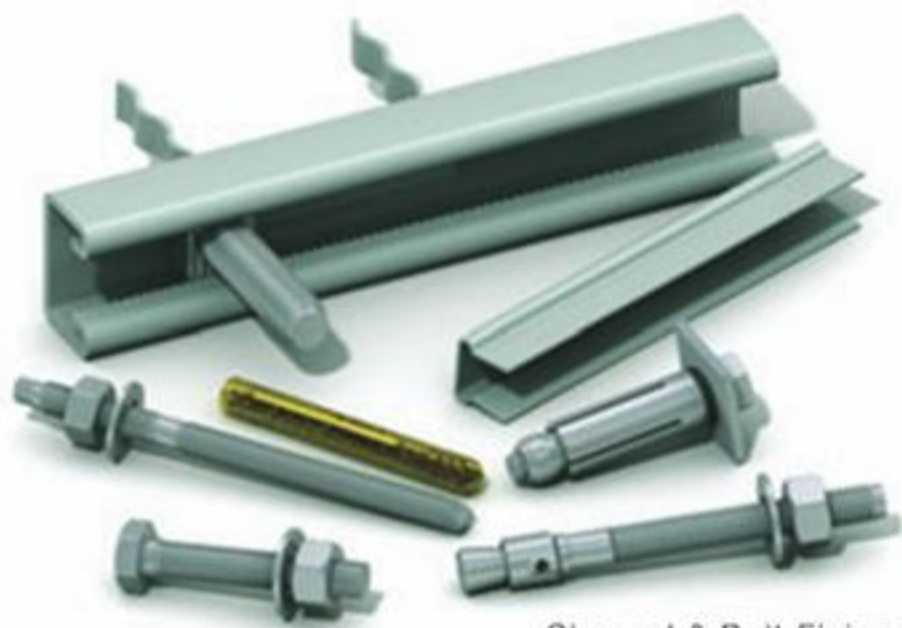

Channel & Bolt Fixings

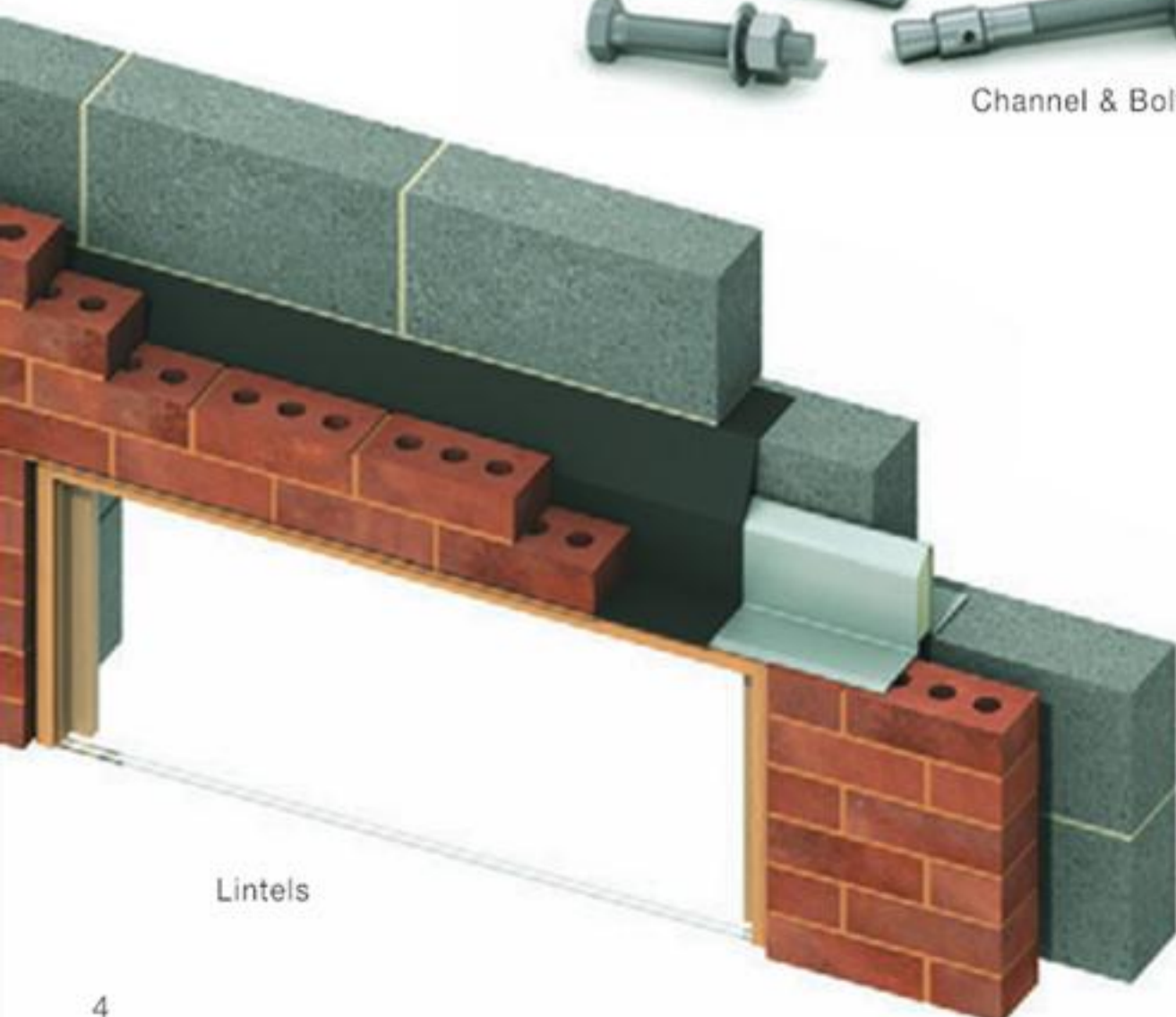

Lintels

Horizontal Support

Masonry Support Systems

Both AnconOptima and the Ancon MDC system provide a continuous angle in the external masonry leaf. AnconOptima is a standard system, available from stock. MDC systems are designed to suit specific applications.

Ancon Individual Brackets are ideal for the support of soldier courses, or brickwork which is either curved on plan or arched.

Stonework supports include corbel angles and adjustable individual brackets.

Masonry Support Systems can now be supplied with Thermal Breaks to minimise heat loss through cold bridging, and improve the energy efficiency of your building project.

Lintels

The Ancon lintel range suits the majority of wall constructions and load conditions. Special lintels can be manufactured to suit architectural features and non-standard applications.

Channel & Bolt Fixings

A wide range of channels and bolts are available to fix stainless steel masonry supports and restraints to any type of structural frame.

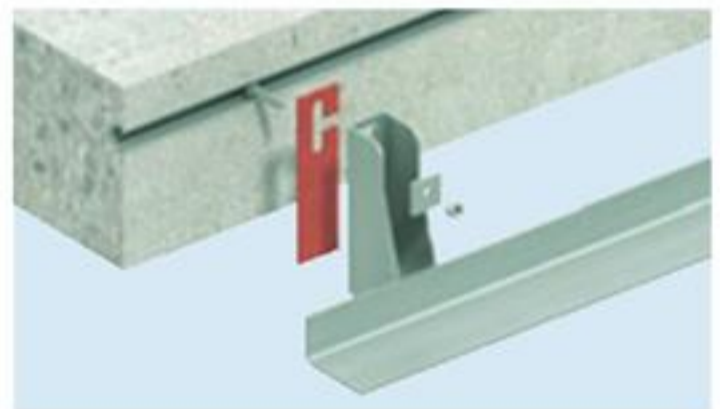

Thermal Breaks

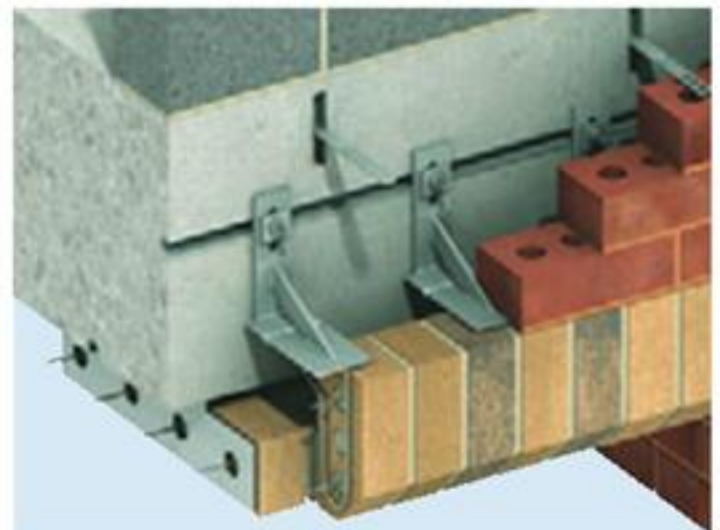

Individual Support Brackets



© Hazle McCormack Young



Windposts

Strengthening Masonry Panels

Windposts & Parapet Posts

Ancon Windposts span vertically between floors. Profiles include channel and angle sections. They are designed to suit specific applications and are supplied complete with all end connections and wall ties.

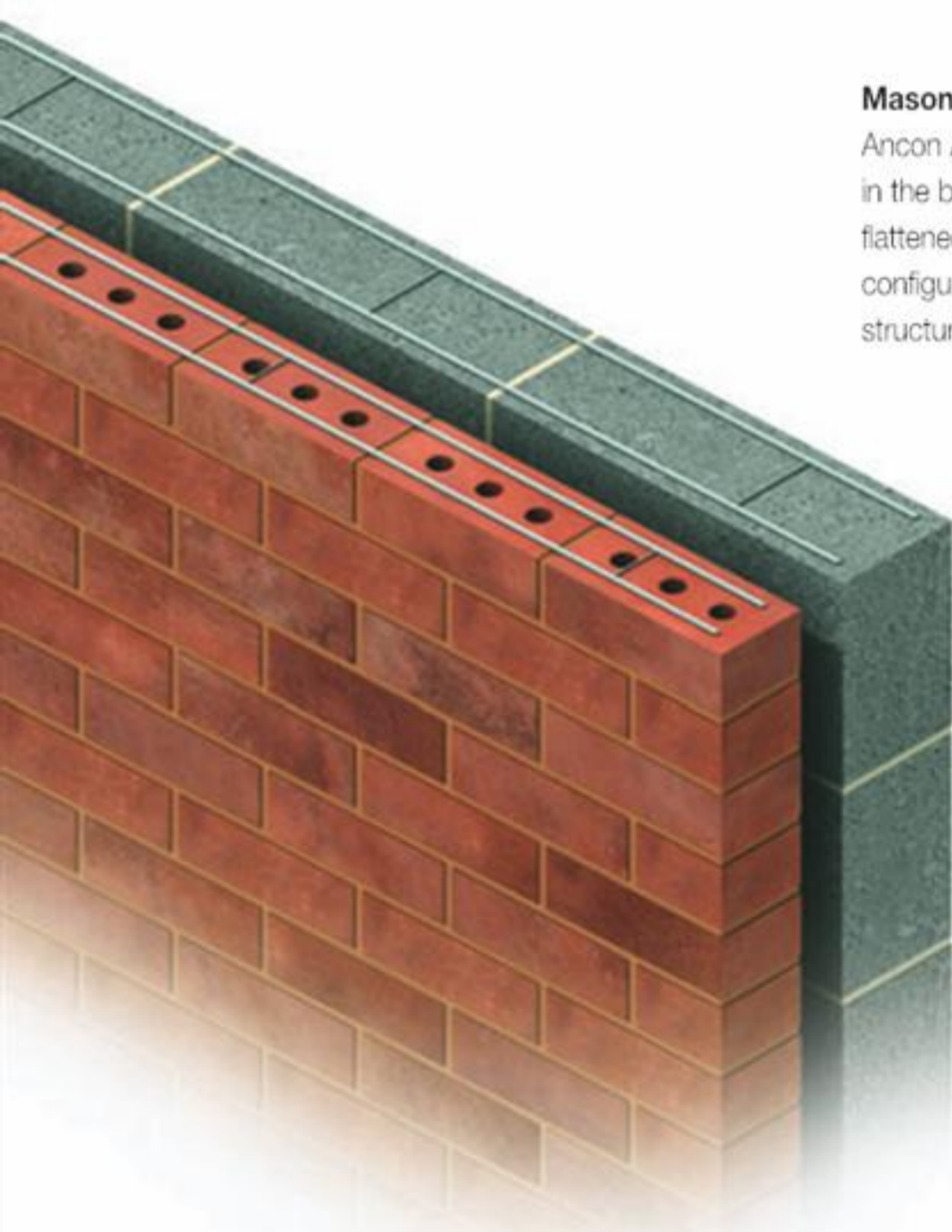

Masonry Reinforcement

Masonry Reinforcement

Ancon AMR masonry reinforcement locates in the bed joint. The longitudinal wires are flattened to less than 3mm. Standard configurations suit a wide range of structural load conditions and wall widths.

further information & services

- Technical Advice
- CPD Seminars
- Masonry Panel Design Service
- Value-Engineered Solutions
- NBS Plus Specification Details
- CAD Profiles
- Layout Drawings
- Project Management
- Installation Guidance
- Technical Literature
- Online Resource 24-7



Tel: +44 (0) 114 275 5224
www.ancon.co.uk

Masonry Restraints

Wall Ties & Other Restraint Fixings

Ancon manufactures wall ties in a variety of lengths and types for restraining brick, block and stone. These restraints can be designed to fix to concrete and structural steel as well as any type of masonry.

The standard wall tie range includes solutions for traditional brick-to-block, thin-joint blockwork, cellular clay blockwork, timber frame and light steel studding. Many products, including those from the Staifix range, can be delivered in 24 hours and are held in stock by distributors.

The range also includes TeploTie basalt fibre wall ties, warm roof batten fixings and products for remedial work including a crack stitching kit.



Stone Restraints



Masonry Passivhaus Development, West Yorkshire

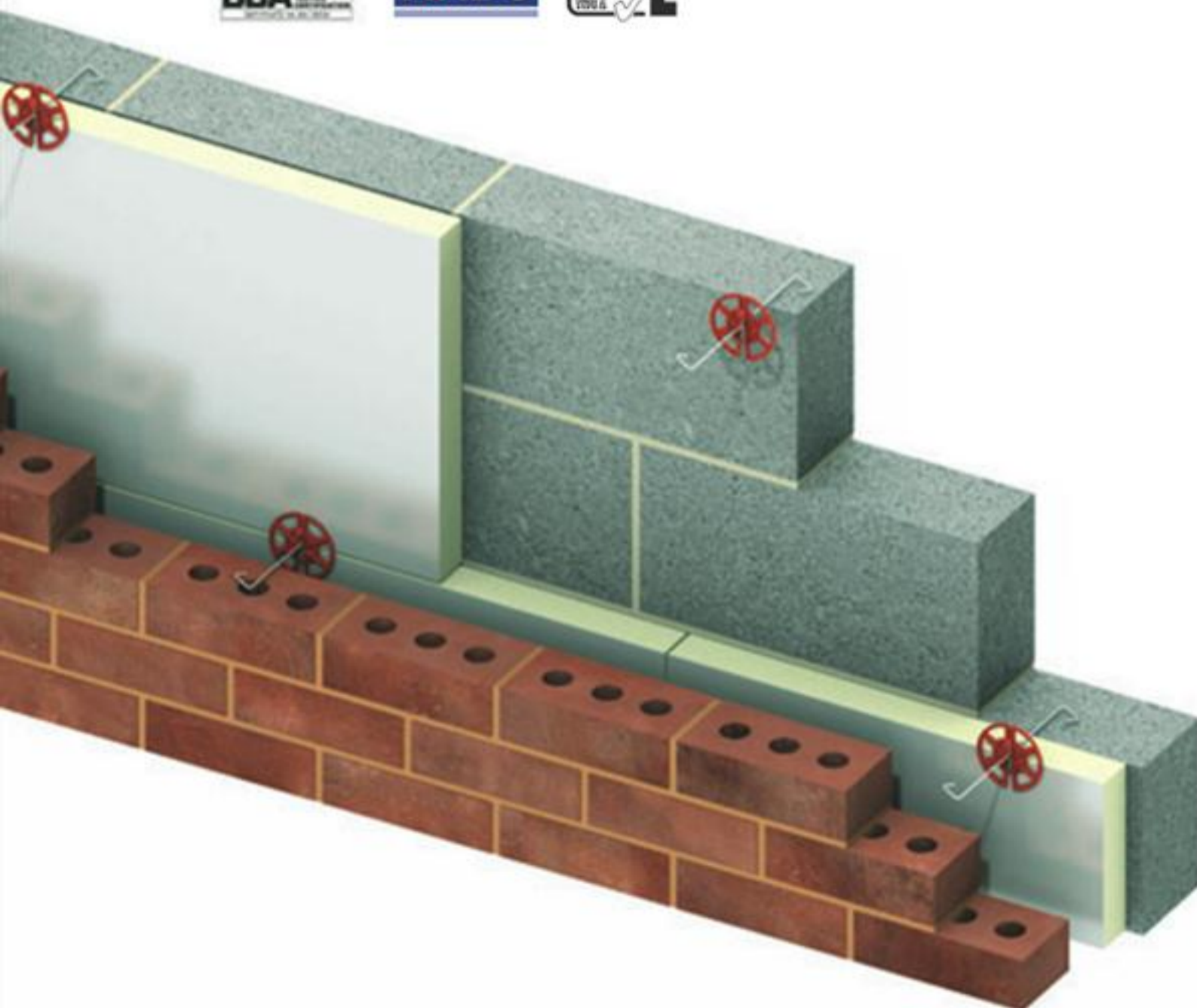

further information & services

- Technical Advice
- NBS Plus Specification Details
- Product Approvals
- CAD Profiles
- Distributor Sales Support
- Technical Literature
- Installation Guidance
- Online Resource 24-7
- Interactive Product Selector



Tel: +44 (0) 114 275 5224
www.ancon.co.uk

Architectural Metalwork



Electro-polished Tension System

Satin-polished Tension System

Hand-polished Tension System

Hand-polished Compression System



© Darcy Schack JAM Photographics Ltd

Tension & Compression Systems

In addition to providing a high load capacity, these stylish Ancon systems meet the demanding aesthetic requirements of today's architectural applications. Both systems are available in carbon and stainless steel in a variety of sizes and finishes including hand polished.

Components combine to create fixing solutions for staircases, canopies, timbers and large areas of glazing.

Tension Systems comprise high strength bar, fork connectors, locking nuts, couplers and anchor discs.

Compression Systems comprise high strength tubes, fork connectors and locking nuts.

further information & services

- Technical Advice
- CPD Seminars
- Design Services
- Product Approval
- NBS Plus Specification Details
- CAD Profiles
- Project Management
- Installation Guidance
- Technical Literature
- Online Resource 24-7
- Interactive Product Selector



Tension System Approval



Tel: +44 (0) 114 275 5224
www.ancon.co.uk

Products for Structural Concrete



DSD Shear Load Connector

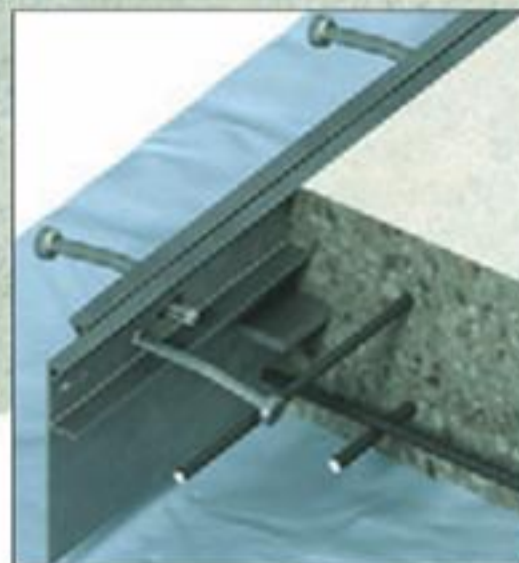

MultiJoint
Patent No. EP1756367



Lockable Dowel
Patent pending

Accommodating Shear

Shear Load Connectors

Installed at expansion and contraction joints, Ancon shear load connectors are more effective at both transferring load and accommodating movement than plain dowel bars. Each connector is a two-part assembly, comprising a sleeve and a dowel component. Products are available for joints in ground bearing and suspended slabs. Free design software is available.

The range includes a unique 'Lockable Dowel' designed for use at temporary movement joints in post-tensioned concrete frames.

Punching Shear Reinforcement

Ancon Shearfix consists of double-headed studs welded to flat rails. It is used within a slab to provide additional reinforcement around columns, protecting the slab from the effects of punching shear. Free design software is available.



Shearfix

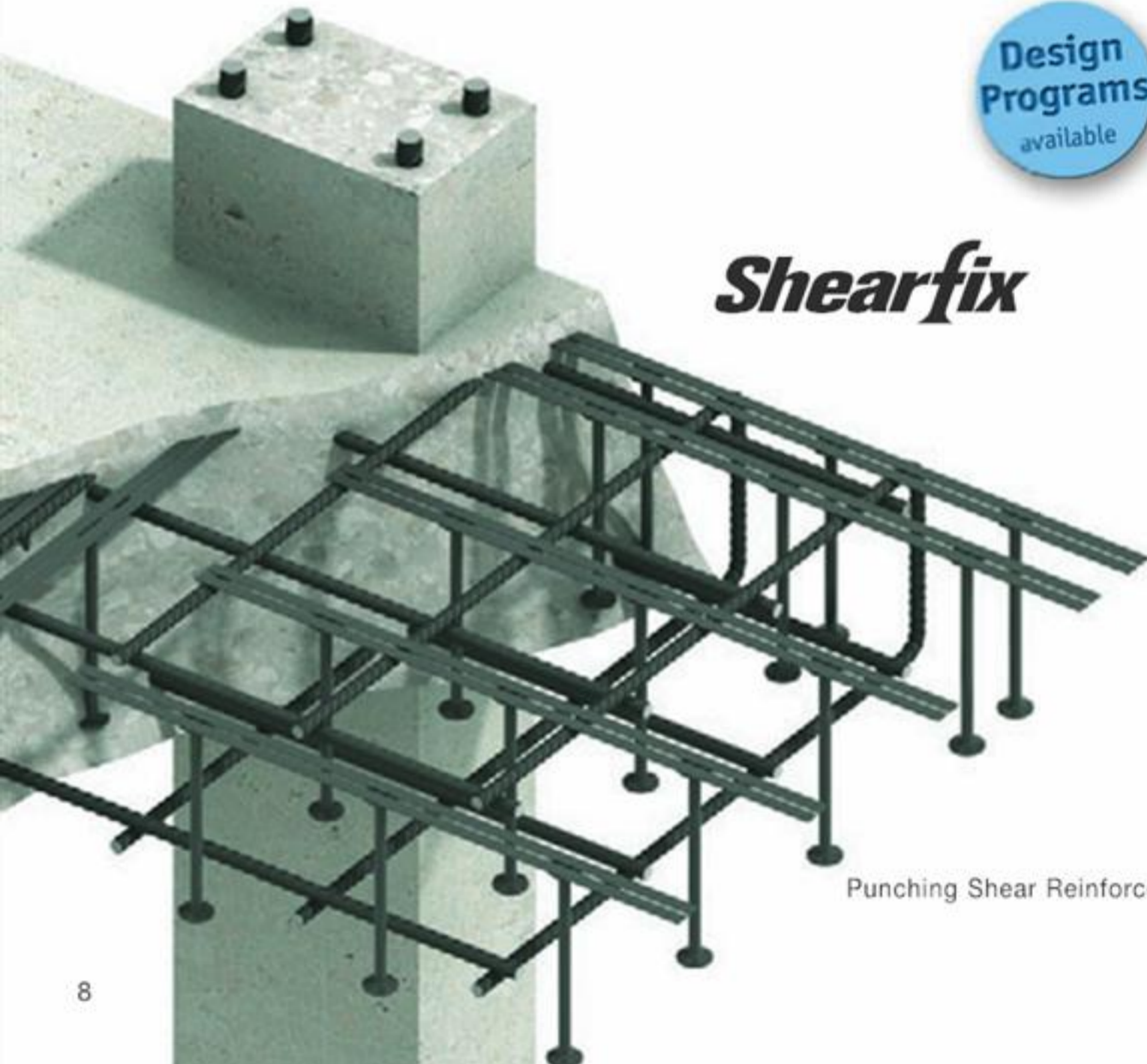

Punching Shear Reinforcement

further information & services

- Technical Advice
- CPD Seminars
- Design Services
- Project Management
- Installation Guidance
- CAD Profiles
- Technical Literature
- Design Software
- Online Resource 24-7



Tel: +44 (0) 114 275 5224
www.ancon.co.uk

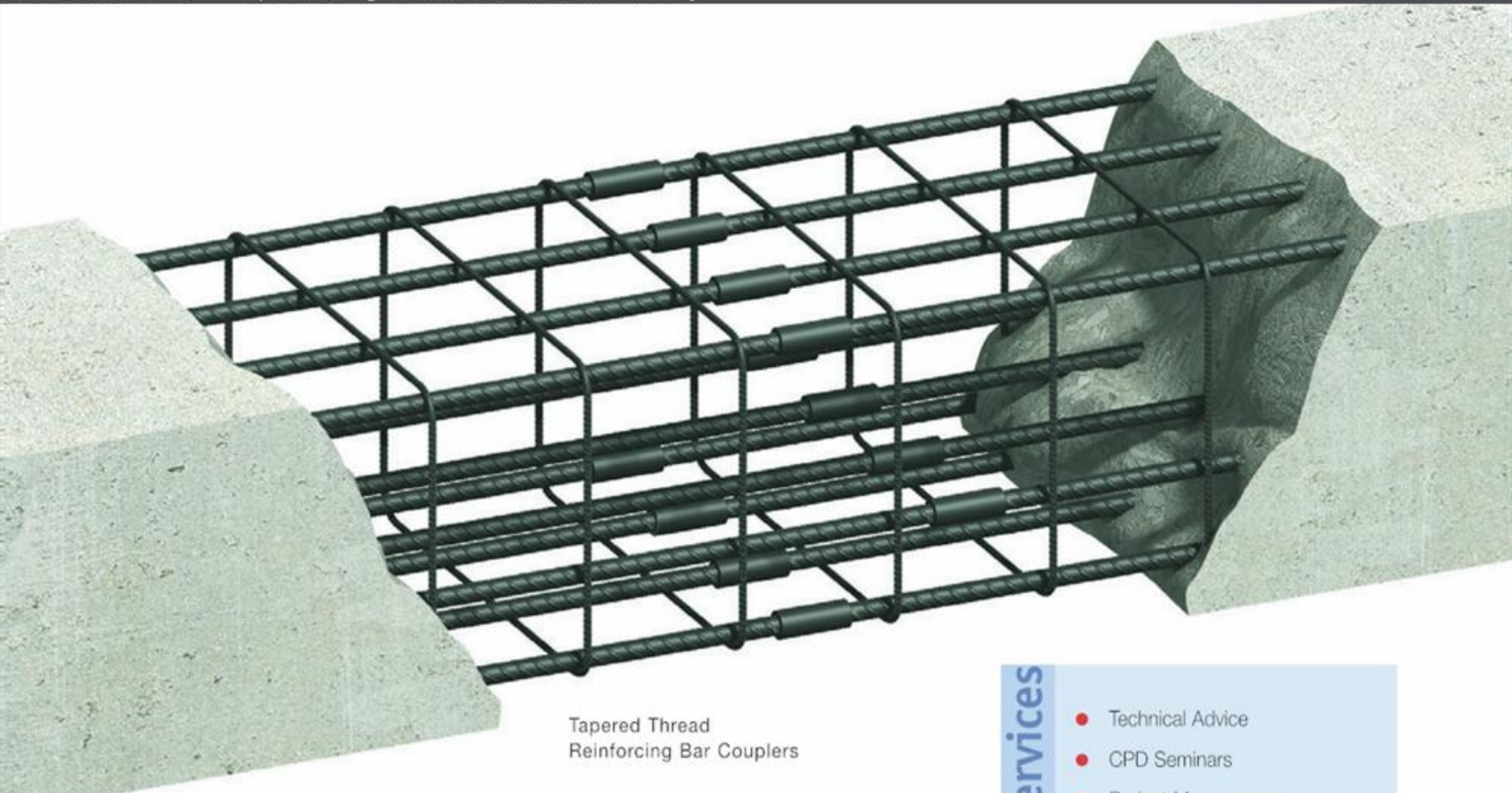

Tapered Thread
Reinforcing Bar Couplers

Continuity of Reinforcement

Reinforcing Bar Couplers

Couplers can be used to replace long bars, simplify design details, reduce rebar congestion and accelerate the speed of construction. The Ancon range includes parallel threaded, tapered threaded and mechanically bolted couplers.



MBT ET
Bolted Coupler

KS Threaded Anchor

Starter Bar System

Reinforcement Continuity Systems

Ancon Eazistrip consists of pre-bent bars housed within a galvanised steel casing. Once installed, the protective cover is removed and the bars are straightened.

Ancon Starter Bars are supplied fixed to an Ancon coupler. Once cast in concrete, the coupler's end cap is removed and a tapered thread continuation bar is installed with a calibrated torque wrench to complete the connection.

The latest addition to the range is the Ancon KS Threaded Anchor, which minimises congestion in a wall. Connection to the anchor can be made with either a Bartec threaded bar or a metric bolt.



Reinforcement Continuity System

further information & services

- Technical Advice
- CPD Seminars
- Project Management
- Distributor Sales Support
- Product Approvals
- Installation Guidance
- Technical Literature
- Online Resource 24-7



Tel: +44 (0) 114 275 5224
www.ancon.co.uk

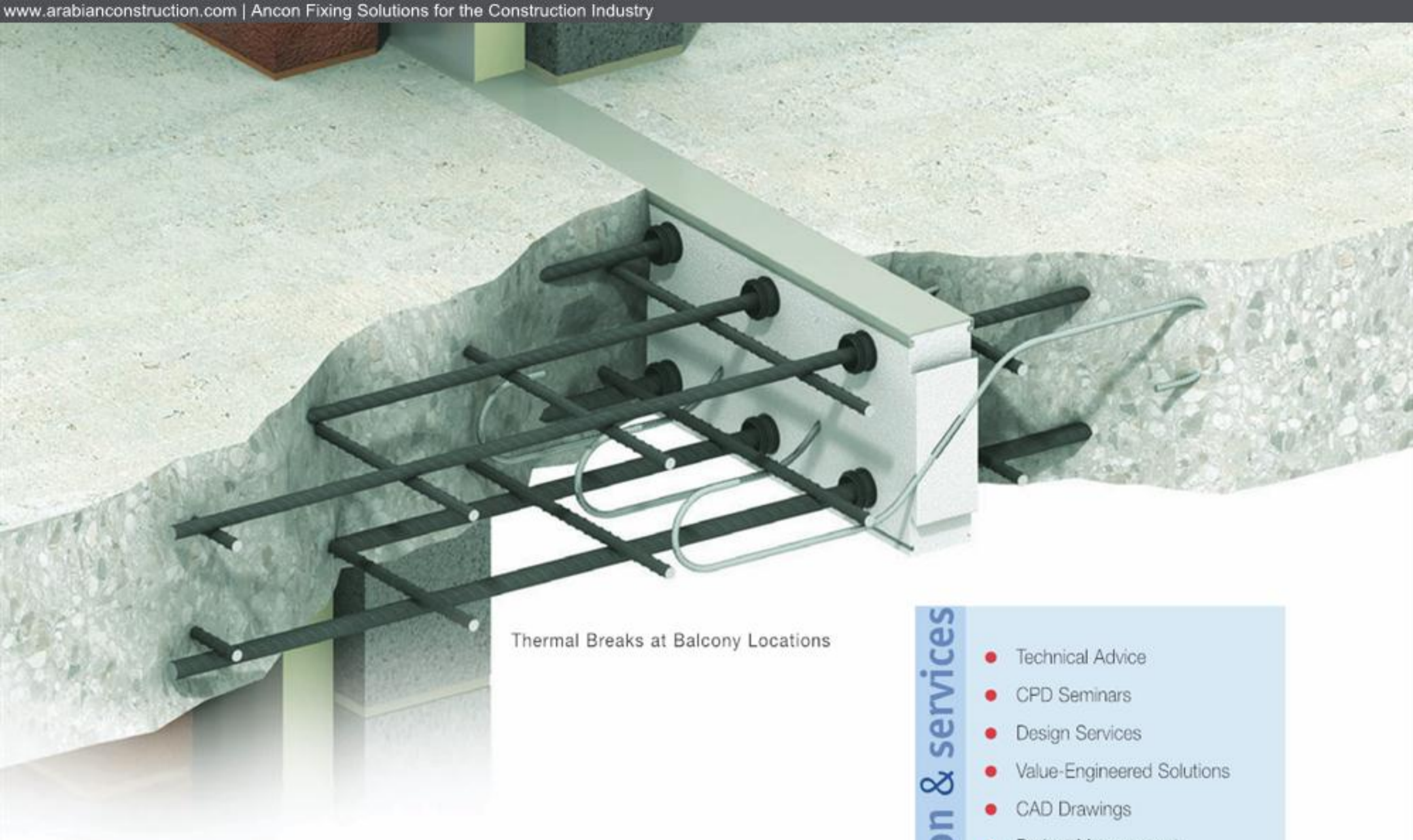

Thermal Breaks at Balcony Locations

Stainless Steel Reinforcement

Thermal Breaks

These systems are used to minimise cold bridging at balcony locations and other places where structural connections pass through the building envelope. Ancon Isolan connectors comprise duplex stainless steel shear reinforcement and rigid CFC-free polystyrene insulation and are used at concrete-to-concrete connections. Thermal breaks for steel-to-steel and steel-to-concrete connections are also available.

Reinforcing Bar

Ancon supplies stainless steel plain and ribbed bar direct from stock. Bars can be supplied cut to length, bent and threaded to suit any application.

Corner Guards

Ancon Corner Guards protect exposed edges of columns and walls in areas of high traffic, such as car parks and warehouses. Where aesthetics are important, stainless steel corner guards can be supplied with a satin-polished surface finish.



Engineered Bar Solutions



Stainless Steel Bar

further information & services

- Technical Advice
- CPD Seminars
- Design Services
- Value-Engineered Solutions
- CAD Drawings
- Project Management
- Installation Guidance
- Technical Literature
- Online Resource 24-7



Tel: +44 (0) 114 275 5224
www.ancon.co.uk

Additional Stainless Steel Solutions



Special Fabrications



Stainless Steel Flooring

Special Fabrications

Ancon has a wealth of experience of working with various types and grades of stainless steel, and produces special fabrications to suit individual customer requirements. Both one-off and volume orders have been supplied to various industries such as Building, Infrastructure, Water Treatment, Nuclear and Mining.

Ancon has an impressive project portfolio in the Tunnelling Industry and is a member of the British Tunnelling Society.



Road Deck Endplates

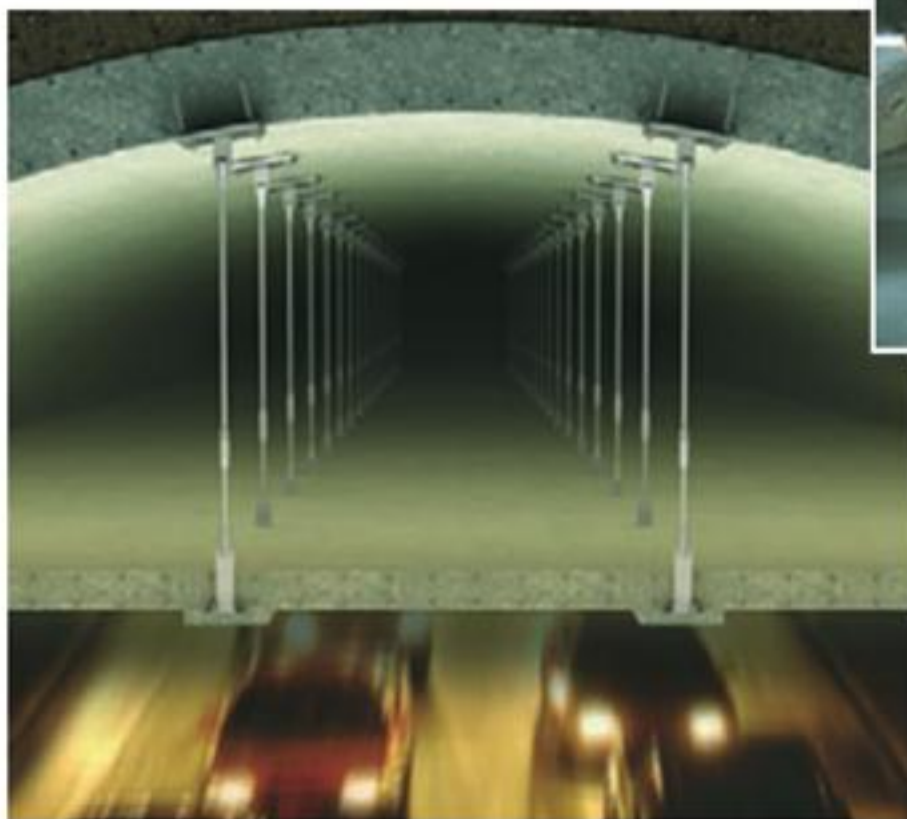

Tunnel Ceiling Suspension Systems



further information & services

- Technical Advice
- Design Services
- Value-Engineered Solutions
- Project Management
- Technical Literature
- Project Portfolio
- Online Resource 24-7



Tel: +44 (0) 114 275 5224
www.ancon.co.uk



Ancon Building Products
President Way, President Park
Sheffield S4 7UR
United Kingdom
Tel: +44 (0) 114 275 5224
Fax: +44 (0) 114 276 8543
Email: info@ancon.co.uk
Visit: www.ancon.co.uk

Ancon (Middle East) FZE
PO Box 17225
Jebel Ali
Dubai
United Arab Emirates
Tel: +971 (0) 4 883 4346
Fax: +971 (0) 4 883 4347
Email: info@ancon.ae
Visit: www.ancon.ae

Ancon Building Products
114 Kurrajong Avenue
Mount Druitt
Sydney
NSW 2770
Australia
Tel: +61 (0) 2 8808 1111
Fax: +61 (0) 2 9675 3390
Email: info@ancon.com.au
Visit: www.ancon.com.au

Ancon (Schweiz) AG
Gewerbezone Widalmi 10
3216 Ried bei Kerzers
Switzerland
Tel: +41 (0) 31 750 3030
Fax: +41 (0) 31 750 3033
Email: info@ancon.ch
Visit: www.ancon.ch

Ancon Building Products GesmbH
Gerspergasse 9/3 Top 1
A-1210 Vienna
Austria
Tel: +43 (0) 1 259 58 62-0
Fax: +43 (0) 1 259 58 62-40
Email: info@ancon.at
Visit: www.ancon.at

Ancon GmbH
Bartholomäusstrasse 26
90489 Nuremberg
Germany
Tel: +49 (0) 911 955 1234 0
Fax: +49 (0) 911 955 1234 9
Email: info@anconbp.de
Visit: www.anconbp.de

These products are available from:

The construction applications and details provided in this literature are indicative only. In every case, project working details should be entrusted to appropriately qualified and experienced persons.

Whilst every care has been exercised in the preparation of this document to ensure that any advice, recommendations or information is accurate, no liability or responsibility of any kind is accepted in respect of Ancon Building Products.

With a policy of continuous product development Ancon Building Products reserves the right to modify product design and specification without due notice.

© Ancon Building Products 2011



ISO 9001: 2008
FM 12226



ISO 14001: 2004
EMS 505377



OHSAS 18001: 2007
OHS 548992