



Uniclass
G251:G321:16815
CI/SfB
141 1921

October 2011

External Wall Insulation & Render Systems

New Build - Swistherm & Swisrail



Maintaining a Flow of Information

www.alumascfacades.co.uk

The Alumasc Facades website provides a wealth of information on all aspects of External Wall Insulation, Render systems and compatible products. Also included are FAQs, file downloads for NBS specification clauses, COSHH information, a CAD library, colour selector and much more.

The image displays the Alumasc Facades website interface and associated technical literature. The website screenshot includes a navigation menu with links for Home, Company, Quality, Environmental, Contact Us, News, Downloads, and Search. A sidebar on the left offers a Product Selector with categories like External Wall Insulation, Render Only Systems, Specialist Systems, Decorative Coatings, System Components, Technical Support, and Approved Contractors. The main content area features a large image of a modern building facade and a section titled 'External Wall Insulation & Render Systems' with a brief description of Alumasc's services. A blog section titled 'Alumasc Facades Blog' features an article about 'Swistharm Helps Leisure Centre Scoop BREEAM Award'. To the right, a brochure titled 'External Wall Insulation & Render Systems' is shown. In the foreground, two more brochures are displayed: one titled 'wide ranging design and specification choices' and another titled 'External Wall Insulation & Render Systems'.

Technical Support

Alumasc Facade Systems are backed-up by comprehensive technical literature and by hands on project support starting with technical and design advice, and extending through site installation to recommendation of appropriate maintenance regimes. Implementation is led by the Alumasc Facades Manager appointed to the project.

Contents

Introduction

■ Alumasc	4
■ Quality and Sustainability	5
■ External Wall Insulation for New Build	6
■ Benefits of External Wall Insulation	7
■ The Alumasc Facades Product Selector	8
■ Design Considerations	10
■ Alumasc Technical Support Services	11

Swistherm

■ Swistherm External Wall Insulation	12
■ The Swistherm System	14
■ Application Details	16

Swisrail

■ Swisrail External Wall Insulation	20
■ The Swisrail System	22
■ Application Details	24

Facades Project Gallery

	30
--	----

Renderers

■ ST Silicone Render	32
■ ST Mineral Render	36

Decorative Coatings

■ Silicone Façade Paint	38
-------------------------	----

Technical Support and Approved Installers

	40
--	----

Swistherm/Swisrail - Installation and Fixing

	42
--	----

Maintenance Advice

	45
--	----

System Components

	46
--	----

Alumasc Premium Products

	48
--	----

Proven Project Track Record

	49
--	----



Also available, External Wall Insulation Systems - Refurbishment (Swisslab and Swisspan systems) covering remodelling social housing, including non-traditional house types.

For further information see pages 50 and 51.

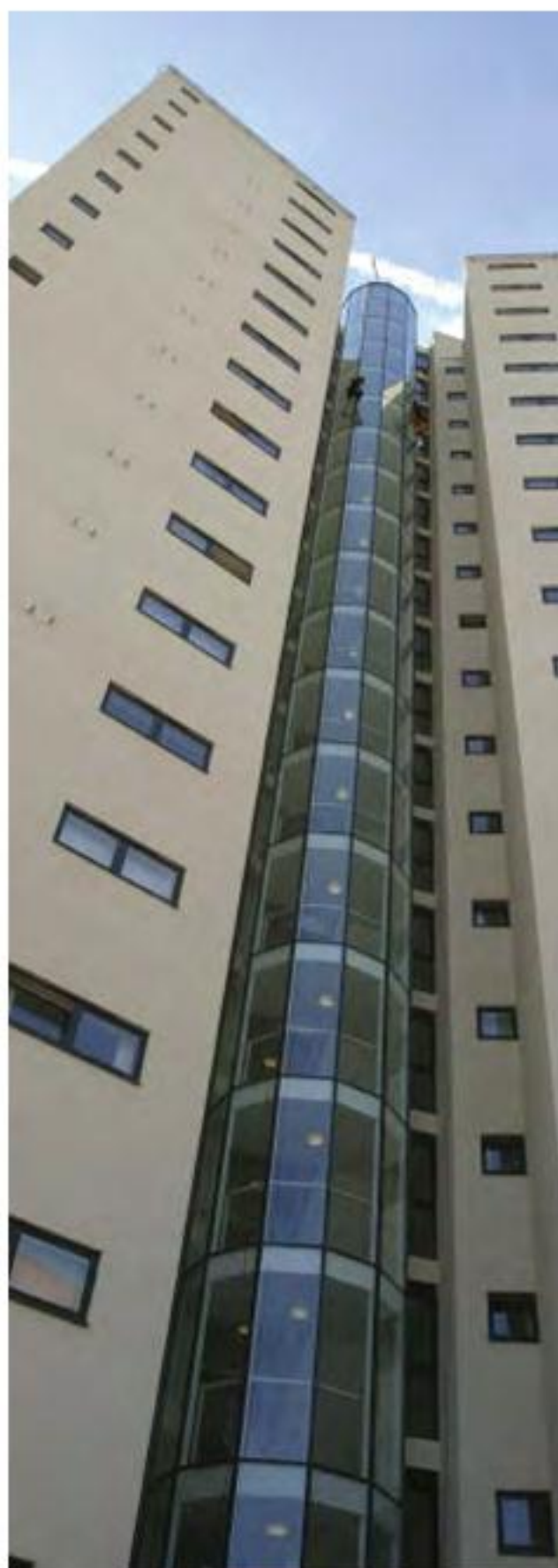

Alumasc - an Introduction

Alumasc Exterior Building Products is part of the Alumasc Group plc. The Group has over 800 employees, generating turnover of around £107 million. The aim is to focus on high quality, environmentally responsible building products within the construction arena in order to deliver first class customer service, long-term solutions and lasting relationships.

About Alumasc

Alumasc Exterior Building Products (Alumasc) is a leading supplier of premium products and systems for specification. The Company has a proven track record in the UK construction industry, accumulated over 60 years, during which time Alumasc products and systems have been used on some of Europe's most prestigious buildings.

Alumasc ensures a high quality of product specification and installation, delivering practical engineered solutions. The Company's commitment to making ongoing improvements is demonstrated through its accreditation to the ISO 14001: 2004 Environmental Management Standard.

By pursuing sustainable building products, systems and manufacturing processes, Alumasc aims to offer specifiers a wide choice of design alternatives, with long-term peace of mind. Recognised brands such as Harmer, Apex, Derbigum, ZinCo, Hydrotech, Firestone and M.R., together with Alumasc's well-known architectural rainwater range have been independently certified, and in some cases have a lifespan in excess of 60 years or for the life of the building.

Alumasc brands are divided into distinct but interrelated groups:

- Rainwater
- Drainage
- Waterproofing
- Façades

Services and Support

Alumasc leads the way in the field of construction product and system manufacture and the delivery of proven solutions. This success is founded on four key areas:

Proven Products

A constantly evolving range of quality proven, world class products and systems, fully accredited to UK, European and North American Standards.

Technical Support

Comprehensive data for specification and use of all products and systems is available in published form, and on the company website. This is backed up by proactive support on a project basis, led by specialist area managers and using the latest CAD and calculation technology.

Approved Contractors

A rigorously trained and monitored installation network for each specialist system to ensure correct application on site.

Warranties

A comprehensive choice of Alumasc warranties, giving protection for up to 20 years, with the additional option of a pre-paid insurance-underwritten warranty, ensuring long-term peace of mind.



Quality and Sustainability

In addition to complying with environmental legislation, Alumasc is committed to developing its own measures to limit the adverse effects of its activities on the environment. To this end, Alumasc operates an environmental policy that fully integrates all aspects of company activities.



Quality

Alumasc operates a quality assurance management system which is independently audited to BS EN ISO 9001: 2008. Alumasc extends this quality management to its network of approved installers, for single source accountability and peace of mind.



ISO 9001: 2008

The ISO 9001 framework governs the management of many aspects of Alumasc support services, manufacturing and transport operations.

Alumasc is committed to continual development and, along with the ISO 14001: 2004 Environmental Management Standard, ISO 9001 provides the tools to monitor and feed back information from all areas of the business to ensure a first class service is maintained.

BBA Certification

Individual Alumasc Facades products and systems are certified by the British Board of Agrément.



Sustainability

Alumasc actively pursues sustainability in the full range of products and systems the company offers through its accreditation to the ISO 14001: 2004 Environmental Management Standard. Alumasc, its partners and its suppliers are committed to putting consideration for the built and wider environment at the core of all aspects of their current business and future development.

ISO 14001: 2004

Alumasc's manufacturing sites at St Helens and Burton Latimer are independently audited to the ISO 14001: 2004 Environmental Management Standard.

Alumasc is committed to achieving improvements, not only as a good neighbour to the surroundings of their manufacturing plants, but in the responsible sourcing of raw materials and monitoring of the impact on the environment as a whole.



Development

Alumasc has within its portfolio a bedrock of environmentally sound products.

Development of existing sound products and practices is central to the success of Alumasc and key to the way in which it provides its proven solutions. Equally, the basis for any new and innovative development is grounded in the knowledge and experience Alumasc has of its core manufacturing materials.

BREEAM Standards

BREEAM points, as a framework for analysis and scoring, allow easy comparison of the relative merits of different construction types and also comparisons between different construction product groups. The BREEAM points system promotes the use of materials with a proven sustainable message and allows designers to differentiate between products with true ecological credentials and those not achieving the benchmark.

Indicative ratings for building materials given in the BRE Green Guide to Specification also allows designers to choose those products or construction methods that will be most beneficial in contributing to a high BREEAM points score.

In the Guide, all insulated render systems on a 140mm solid blockwork external wall achieved the highest A+ rating. Alumasc EWI systems achieve equally high ratings when used to upgrade existing dwellings and are highly rated in the responsible sourcing of materials.

External Wall Insulation for New Build

The changing face of construction in the 21st century, ever-higher thermal performance, fast track construction and urban regeneration, have influenced the way we design and construct our buildings. As a consequence, the specification of external wall insulation is becoming a mainstream method of creating high performance, commercially beneficial facade systems.

Alumasc External Wall Insulation systems can be applied to most common types of construction - from steel frame to solid masonry.

Solid Wall Construction

Traditionally external wall insulation has been applied to solid masonry and concrete walls. These provide continuous support for the insulation and allow fixings to be installed at any point. Alumasc's Swisitherm External Wall Insulation system is designed to be fixed to solid backgrounds.

Framed Construction

The increased use of fast track construction and, in particular, steel frame, has resulted in the development of external wall insulation systems designed to be fixed to framed buildings. For framed constructions, the NHBC requires a drainage cavity be formed between the insulation and the structural frame. Alumasc's Swisrail External Wall Insulation system is designed to be fixed to framed construction. Swisrail is NHBC compliant and features a drainage cavity between the insulation and the structural frame.

External Wall Insulation Systems

Alumasc External Wall Insulation systems are suitable for application to a wide variety of construction types within the new build sector. This ranges from the use of cement particle boards on lightweight steel and timber construction, through to dense masonry and high performance insulation Passiv Haus specifications.

With the ever-changing demands of buildings in terms of ecological and thermal performance, cost and life expectancy, the Alumasc Facades Technical teams are able to tailor specifications to suit the requirements of individual buildings based on a track record of proven, BBA approved products and systems.



Table 1: New Build Construction Types & Compatible Systems

Construction Types	Swisitherm	Swisrail
Solid Structure		
Masonry	✓	-
Concrete	✓	-
Frame Structure		
Steel Frame	✓	✓
Concrete Frame	✓	✓
Modular		
Timber Frame	✓	✓
SIPs	✓	✓
Steel Frame	✓	✓
Thin Joint Blocks	✓	-
MWC	✓	✓
Ecobuild		
Passiv Haus	✓	✓
Rammed Earth	✓	-
Clay Blocks	✓	-

Full details on the Swisitherm and Swisrail external wall insulation systems can be found on pages 12-27 of this brochure.

For alternative applications, please refer to the Swislab and Swispan systems, as outlined on our website or separate Refurbishment Technical Brochure.

Benefits of External Wall Insulation

Why should I consider External Wall Insulation?

Protects the structure

An External Wall Insulation system provides a weatherproof jacket to protect the fabric of the building from the elements, keeping it warm and prolonging its life.

Reduces heat loss

Placing insulation on the outside of the building structure is the most effective way of insulating a building – the ‘tea cosy’ effect. With EWI, the thickness of insulation is not restricted by cavity width, nor does it reduce internal room sizes.

No thermal bridging

External Wall Insulation ensures that there is a continuous layer of insulation encapsulating the building, avoiding thermal bridges and the risk of interstitial condensation that can affect some other methods of insulation. Internal temperature fluctuations are reduced, especially if the building has high levels of thermal mass.

Striking facades

Alumasc EWI systems are finished with a choice of modern formulation, lightweight renders in a range of textures and colours. The use of beads and trims ensures sharp edges and clean lines.

Low maintenance

The render finishes used within an EWI system are designed to be virtually maintenance-free and self-cleaning. In line with good practice for building maintenance, checks are required on movement joints, etc and general building maintenance advised to ensure the longevity and performance of the system.

Proven track record

Alumasc have been a key exponent of External Wall Insulation systems in both the newbuild and refurbishment sectors since 1985. With over 5 million square metres installed, Alumasc has earned market leading status and numerous industry awards.

Alumasc Swisitherm System



Alumasc Swisrail System



Modern, Lightweight Render Finishes

The renders that are an integral part of the Alumasc Swisitherm and Swisrail systems are lightweight, high performance renders that are weather resistant, yet vapour permeable.

The formulations of Alumasc Silicone and Mineral Renders and the integral closeness glass fibre reinforcement make them much more resistant to shrinkage cracking than traditional sand and cement renders. This enables large areas to be rendered seamlessly with total colour consistency.

The Alumasc Facades Product Selector

Alumasc External Wall Insulation systems, Render Finishes and Decorative Coatings can be selected via a number of routes - be it by construction type, specification requirements or individual product or system. The information on these pages can be read in conjunction with the Facades product selection tools available on our website.

External Wall Insulation Systems



Swistherm Lightweight EWI System

Application

Used where the structure can provide continuous support for the insulation

Fixing Method

Direct adhesive/mechanical fixing to a masonry substrate

Insulation Options

Mineral Wool, FRA grade EPS, Cork

Render and Coatings Options

Silicone Render, Mineral Render, Silicone Façade Paint, Acrylic Render, Acrylic Brick Slips



Swisrail Lightweight EWI and Rail System (NHBC Approved)

Application

Designed for use on framed buildings subject to NHBC approval

Fixing Method

Via vertical support rails providing a gap between the insulation and the structure

Insulation Options

Mineral Wool, FRA grade EPS, Cork

Render and Coatings Options

Silicone Render, Mineral Render, Silicone Façade Paint, Acrylic Render, Acrylic Brick Slips

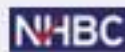

The Alumasc Facades Product Selector

Render Only Systems



ST Lightweight Render Only System

Application

Contemporary finishes for new build and remodeling applications

Render Only

For direct application to masonry blockwork and brickwork only

Render and Coatings Options

Silicone Render, Mineral Render, Silicone Façade Paint, Acrylic Render

ST Silicone through-colour and ST Mineral Renders

Rolled Texture Finishes



ST Silicone Renders in rolled textures and an extensive range of non-fading through colours.

ST Mineral Renders in rolled textures that can be painted if desired with ST Silicone Façade Paint.

For full details of the Alumasc range of Renders, Finishes and Decorative Coatings, please refer to pages 32 - 39.

Silicone Façade Paint

Extensive Colour Range Available



Design Considerations



Alumasc Facade solutions are based on extensive experience, over many years, of UK construction projects. This experience is fed back into the design process at all project stages by our sales and technical support teams. Below are a number of key areas to consider when specifying a render only or external wall insulation system.

Inclusion of Alumasc at the outset of the design and specification process will allow all elements from location to budget to be taken into consideration at the earliest stages.

Substructure choice

- Has a bearing on the need for movement joints and ultimately the continuity of render treatment

Insulation choice

- Determines detailing decisions with regard to apertures and high traffic areas
- Thermal performance requirements, budget and environmental considerations influence insulation choice

Render choice

- Determined from both an aesthetic, performance and maintenance perspective
- Silicone renders have the highest performance levels for resistant to dirt

Colour choice

Alumasc provide a full palette of colours and are able to advise on the suitability with regard to long term colour retention, weathering and the use of dark colours on large scale details.

Complementary Component choice

The choice of system components such as beads and fixings is very much dependent on specific project details. Determining and sticking to the complete specification is paramount in achieving the desired result.

Choice of Insulation - Comparative Performance

Insulation Properties:	Mineral				
	Wool	EPS	Cork	Phenolic	PIR
Thermal conductivity w/m ² k	0.036	0.037	0.038	*0.020 to 0.022	*0.026 to 0.028
Fire Performance	///	✓	///	///	///
Emissions Production	///	✓	///	✓	✓
Recyclability	///	X	///	X	X
Impact resistance	///	///	///	///	///
Cost	///	///	✓	///	///

Key: /// = Excellent, // = Good, / = Adequate, X = Poor

* Note: Thermal conductivity varies, depending on board thickness.

Choice of Render Finish - Comparative Performance

Binder:	Mineral				
	Silicone Resin	Render	Acrylic Resin	Sand and Cement	Lime
Properties:					
Adhesion	///	///	///	✓	✓
Water Repellency	///	///	///	X	X
Vapour Permeability	///	///	///	///	///
Crack Resistance	///	///	///	X	X
Weather Protection	///	///	///	✓	✓
Durability	///	///	///	✓	✓
Algae Resistance	///	///	///	X	✓

Key: /// = Excellent, // = Good, / = Adequate, X = Poor

Alumasc Technical Support Services



Alumasc provides a fully comprehensive and seamless package of advice and hands on management back up, extending through site installation to warranties and maintenance schedules. Implementation is led by the Alumasc Facades Manager appointed to the project.

Alumasc Technical Services can advise on all aspects of product selection, specification and integration of Alumasc systems into any building design. Specific technical advice is always available through our Area Sales Managers, Site Support Technicians or Technical Services team.

Technical Support

- Thermal and wind load calculations
- Detailed NBS specifications
- Project specific CAD working drawings
- Coloured elevational rendering for project visualisations
- Material safety (COSHH) and product data sheets
- Performance and risk assessments on installation requirements for high rise buildings
- For remodelling projects, pull out tests and condensation analysis
- Budget costs via approved contractors

Project Monitoring

- Regular site visits to provide quality assurance and technical support
- Final inspection of the work to ensure warranty compliance
- Appropriate recommendations made for maintenance regimes to fulfil warranty requirements

National Network of Approved Contractors

A network of carefully selected contractors, all of whom have received instruction in the installation techniques for Alumasc Facades systems and whose project performance is rigorously monitored in terms of:

- Compliance with project specifications and project programmes
- Good working practice on site and health and safety procedures

Facade Systems Warranties

- Alumasc offers a comprehensive choice of warranties covering both product and installation to suit the specified design life of the installed product
- Alumasc backed warranties are available for 10 or 15 years supported by public and product liability insurances of up to £50 million
- Alumasc can also arrange third party insurance backing giving up to 20 years cover subject to independent final inspection, documented compliance with an agreed maintenance schedule and pre-payment of the relevant premium



NB: Warranties are only offered on Facades projects that have been installed by an Alumasc Approved Contractor, in accordance with the relevant project specification and Alumasc Quality Assurance scheme ruling at the time of application.

Swistherm External Wall Insulation

Swistherm is a lightweight, thin coat insulated render system suited to contemporary and new build applications. Insulation slabs are mechanically fixed direct to a continuous substrate. Swistherm is faced with Alumasc's range of Silicone or Mineral renders which are available in a choice of textures and colours.



Swistherm External Wall Insulation



Applications

- New Build - where structure provides continuous support for insulation slabs
- Construction Types - primarily suited to new-build construction
- Buildings up to and including 5 storeys - standard installation subject to location
- High Rise applications - suitable subject to Alumasc's high rise policy

Performance

- BBA approved, fully warranted system with life expectancy in excess of 30 years
- Manufactured under ISO 9001: 2008 and ISO 14001: 2004 Quality and Environmental Management systems
- Fully weather resistant whilst remaining vapour permeable
- Allows the fabric of the building to act as a heat store, increasing thermal mass
- Eliminates cold bridging, condensation and mould growth
- Highly resistant to impact damage
- Protects structural fabric, limiting movement and thermal shock and freeze-thaw cycles associated with traditional brickwork facades
- Rated Class 0 for surface spread of flame



Insulation and Finishes

- Choice of insulation thicknesses and materials, achieving very low U-values
- Insulation is mechanically fixed direct to continuous substrate
- Lightweight, through-coloured renders include ST Silicone, Acrylic and Mineral
- Natural option consisting Mineral Wool or Cork insulation with Mineral render

Installation and Maintenance

- Installed by approved specialist contractors
- Requires minimal routine maintenance



Swistherm - The System

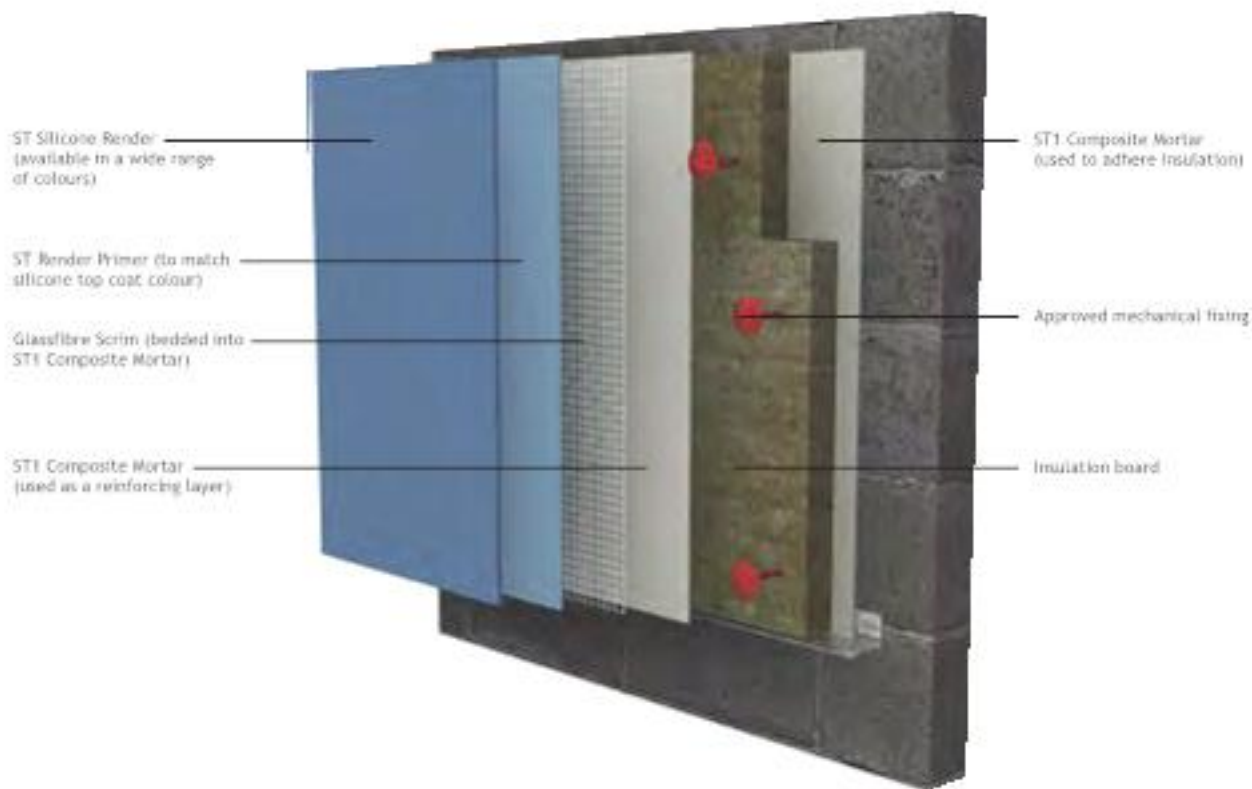

Swistherm External Wall Insulation

Alumasc Swistherm is a thin-coat insulated render system that is ideally suited to new build applications. Swistherm is designed to satisfy differing substrate conditions and building height requirements.

Insulation slabs are adhesive and mechanically fixed direct to a continuous substrate and faced with a durable render topcoat. The render surface texture can be rolled and is available in an exceptional range of colours.

Alumasc ST Silicone Renders with through-colour offer a top performance option. ST Mineral Renders are available as a natural option and can be coated with ST Silicone Façade Paint.

Insulation Choice

Type	Swistherm
Mineral Wool	✓
EPS	✓
Cork	✓
Phenolic	-
Polyisocyanurate (PIR)	-

Render & Coating Choice

Type	Swistherm
Silicone Render	✓
Acrylic Render	✓
Mineral Render	✓
Polymer Dash Render	-
Polymer Plain Render	-
Rendabrick	-
Traditional Brick Slips	-
Acrylic Brick Slips	✓
Silicone Façade Paint	✓
Masonry Paint	-

Typical Construction Types

Type	Swistherm
Solid Structure	
Masonry	✓
Concrete	✓
Framed Structure	
Steel Frame	✓
Concrete Frame	✓
Modular	
Timber Frame	✓
SIP's	✓
Steel Frame	✓
Thin Joint Blocks	✓
MMC	✓
Ecobuild	
Passiv Haus	✓
Rammed Earth	✓
Clay Blocks	✓



The Swistherm system has been approved by the BBA since 1988 and is currently covered by Certificate No 00/3766, with specific data sheets for individual insulants and render finishes.



NBS Clauses can be downloaded from the Alumasc website.



Swistherm - The System



Swistherm - Application Details

Swistherm base detail (section)

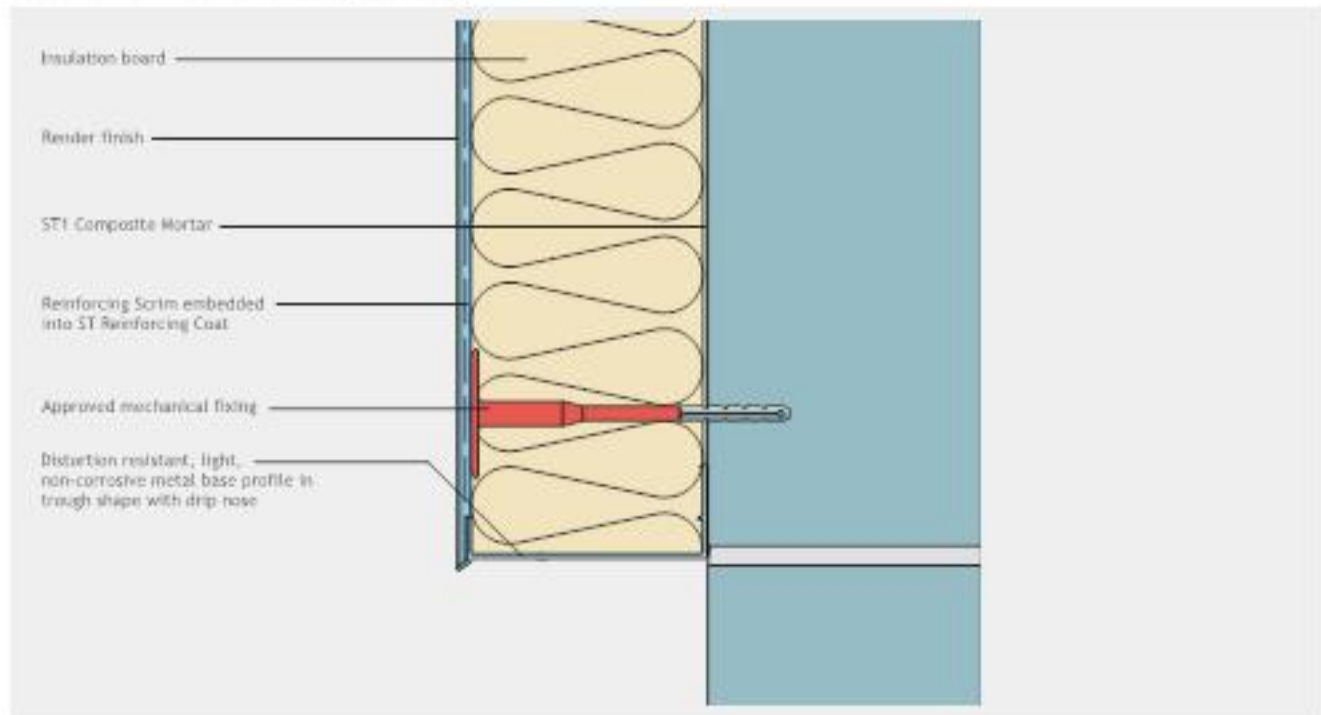

Swistherm corner detail (plan)

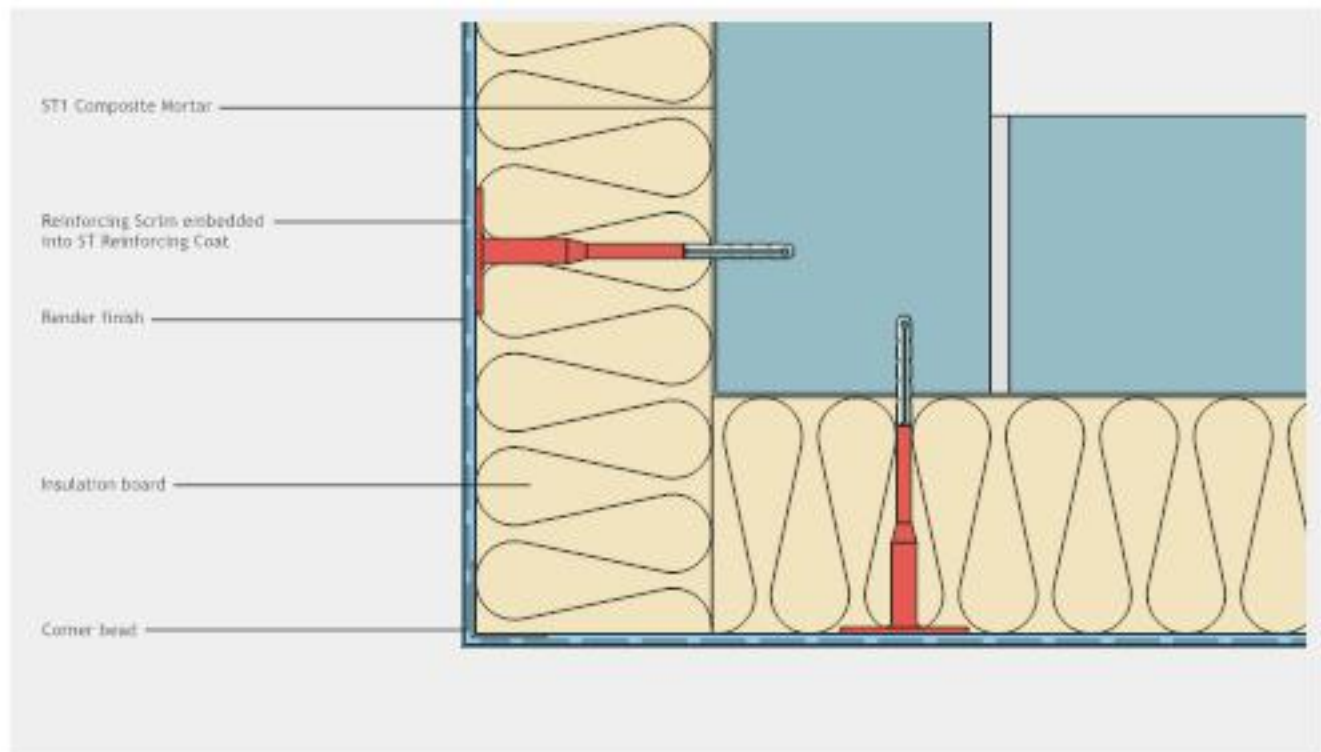

Swistherm - Application Details

Swistherm window jamb detail (plan)

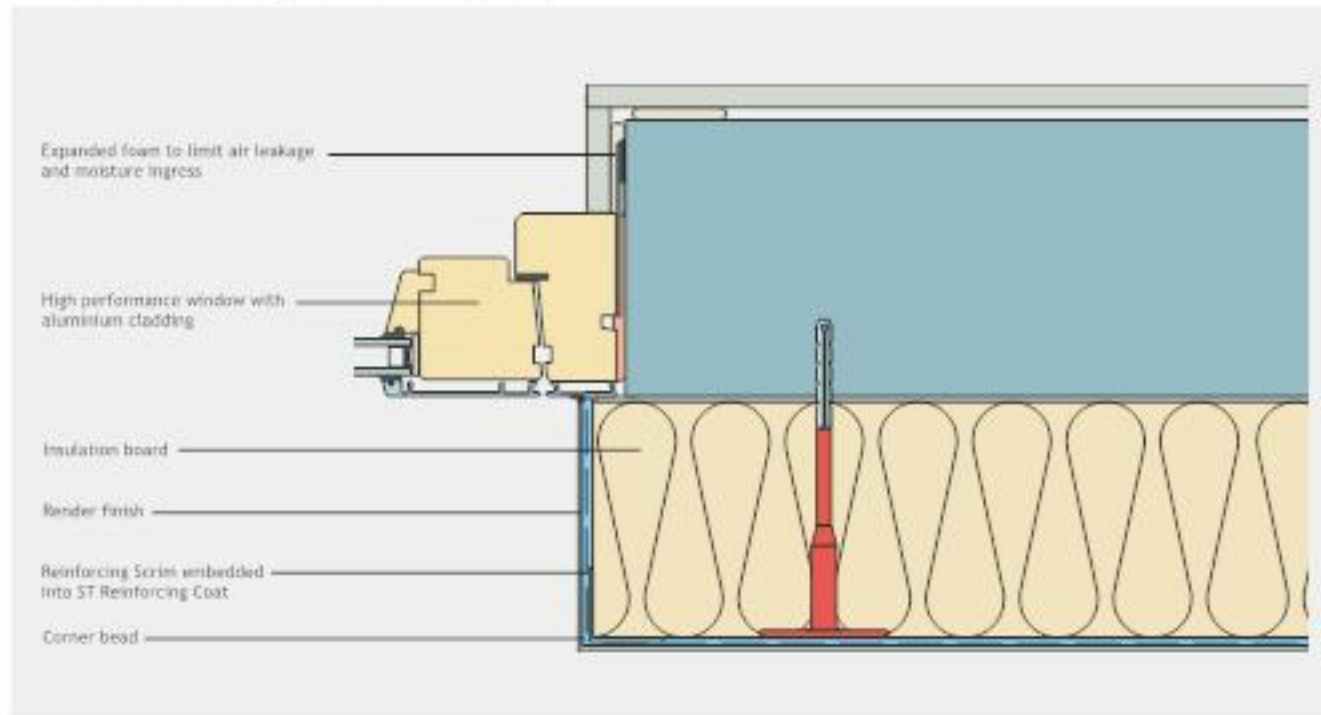

Swistherm expansion joint detail (plan)

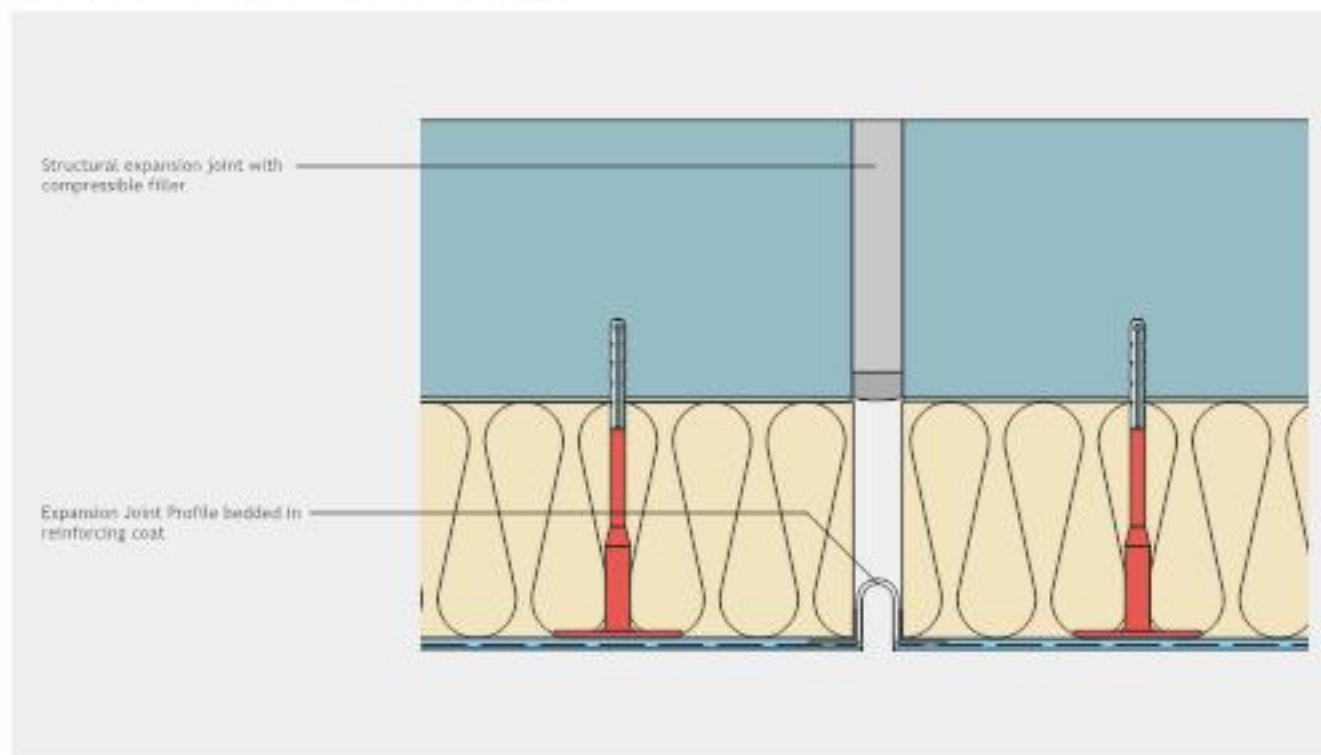

Swistherm - Layout and Fixing

Required Number and Arrangement of Fixings

All Swistherm fixing recommendations are subject to a site pull out test carried out by an Alumasc approved agent.

Because of varying wind pressure loads, more fixings will be needed in corner zones than in central surfaces, depending on the ground plan and the building height. The width of the corner zone 'R' depends on the building width 'a' (narrow side of the building).

Typical Ground Plan

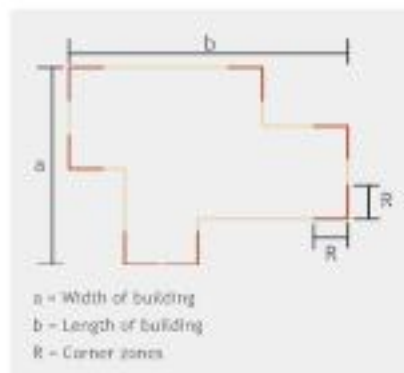

Low Rise Fixing Pattern Layout

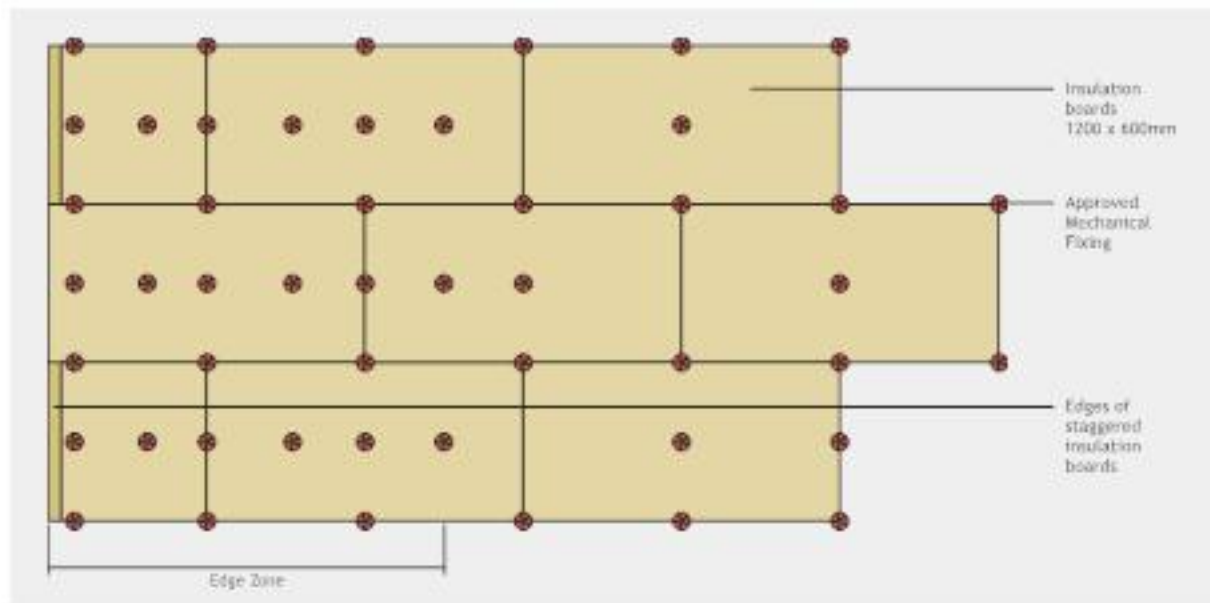

Swistherm - Layout and Fixing

High Rise Policy

High rise projects are subject to Alumasc Board approval and compliance with Alumasc's current High Rise Policy.

- Schemes are to be a maximum height of 20 storeys
- In all cases an independent Structural Engineer must be appointed to advise on the suitability of the proposed external wall insulation system specification and detailing on the particular building
- Projects are subject to the following specification clause:

'In preparing this specification we have assumed that the structure of the building to which it relates is absolutely sound and free from defects in all respects. We have not carried out or commissioned a structural survey of the building and recommend that you consider this course of action if you have not already done so.'

The width of the corner zone is at least 1m, with a maximum of 2m. However, the following values apply owing to the practicalities of the fixing arrangement:

Building width	Corner zone R
up to 9m	1.0m
9 to 13m	1.5m
over 13m	2.0m

Fix using Swistherm Impact fixings or Expansion fixings. Project specific fixing patterns will be supplied by Alumasc Technical Services.



High Rise Fixing Pattern Layout

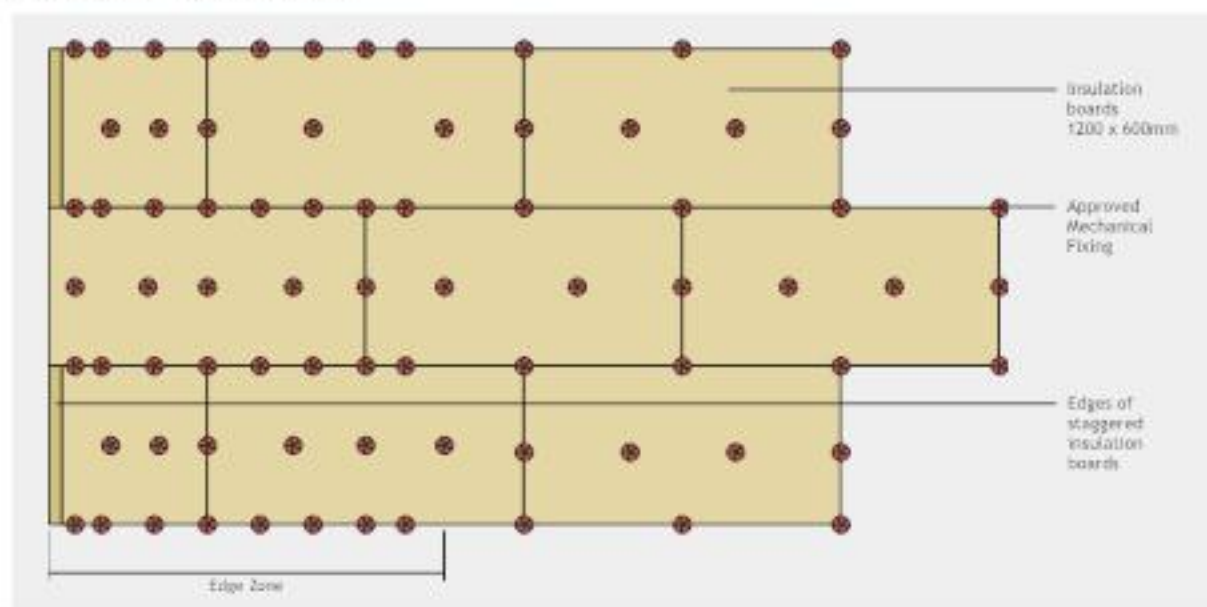

Swisrail - External Wall Insulation

Swisrail is an external wall insulation system specifically designed for use on framed buildings subject to NHBC approval. The system incorporates a drained cavity between the insulation and the structural frame to comply with NHBC guidelines. It is faced with a range of lightweight, through coloured renders with a rolled surface texture.



Swisrail - External Wall Insulation



Applications

- New Build - for use on framed buildings subject to NHBC approval
- Construction Types - primarily suited to new-build construction
- Buildings up to and including 5 storeys - standard installation subject to location
- High Rise applications - limited suitability subject to Alumasc's high rise policy

Performance

- Fully warranted system with life expectancy in excess of 30 years
- Manufactured under ISO 9001: 2008 and ISO 14001: 2004 Quality and Environmental Management systems
- Fully weather resistant whilst remaining vapour permeable
- Allows the fabric of the building to act as a heat store, increasing thermal mass
- Eliminates cold bridging, condensation and mould growth
- Highly resistant to impact damage
- Protects structural fabric, limiting movement and thermal shock and freeze-thaw cycles associated with traditional brickwork facades
- Rated Class 0 for surface spread of flame



Insulation and Finishes

- Choice of insulation thicknesses and materials, achieving very low U-values
- Insulation is mechanically fixed direct to continuous substrate
- Lightweight, through-coloured renders include ST Silicone, Acrylic and Mineral
- Natural option consisting Mineral Wool or Cork insulation with Mineral render

Installation and Maintenance

- Installed by approved specialist contractors
- Requires minimal routine maintenance



Swisrail - The System

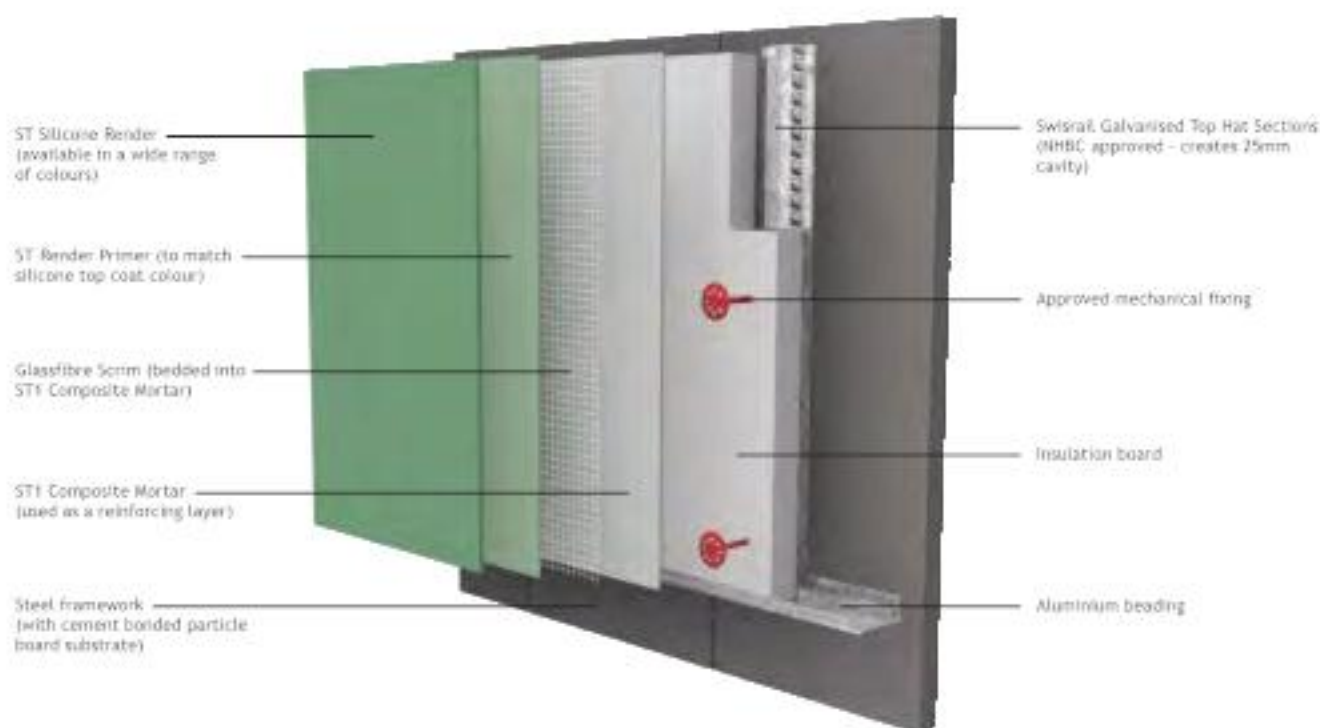

Swisrail - The System

Alumasc Swisrail is a lightweight, thin-coat insulated render system specifically designed for use on framed buildings subject to NHBC approval. A system of steel rails and channels provides a drained cavity between the insulation and the steel frame to comply with NHBC guidelines, including:

- A 15mm minimum drained cavity
- Adequate means of water collection and drainage to the exterior
- Effective means of firestopping within the cavity

Insulation is mechanically fixed to the galvanised steel rails and faced with a durable render topcoat. The render surface texture can be rolled and is available in an exceptional range of colours.

Alumasc ST Silicone Renders with through-colour offer a top performance option. ST Mineral Renders are available as a natural option and can be coated with ST Silicone Façade Paint.

Insulation Choice

Type	Swisrail
Mineral Wool	✓
EPS	✓
Cork	✓
Phenolic	-
Polyisocyanurate (PIR)	-

Render & Coating Choice

Type	Swisrail
Silicone Render	✓
Acrylic Render	✓
Mineral Render	✓
Polymer Dash Render	-
Polymer Plain Render	-
Rendabrick	-
Traditional Brick Slips	-
Acrylic Brick Slips	✓
Silicone Façade Paint	✓
Masonry Paint	-

Typical Construction Types

Type	Swisrail
Framed Structure	
Steel Frame	✓
Concrete Frame	✓
Modular	
Timber Frame	✓
SIP's	✓
Steel Frame	✓
Thin Joint Blocks	-
MMC	✓
Ecobuild	
Passiv Haus	✓
Rammed Earth	-
Clay Blocks	-



The Swisrail system has been approved by the BBA since 1988 and is currently covered by Certificate No 00/3766. Swisrail is a derivative of this system.



NBS Clauses can be downloaded from the Alumasc website.



Swisrail - The System



Swisrail - Application Details

Swisrail cavity detail - main spacer rail (plan)

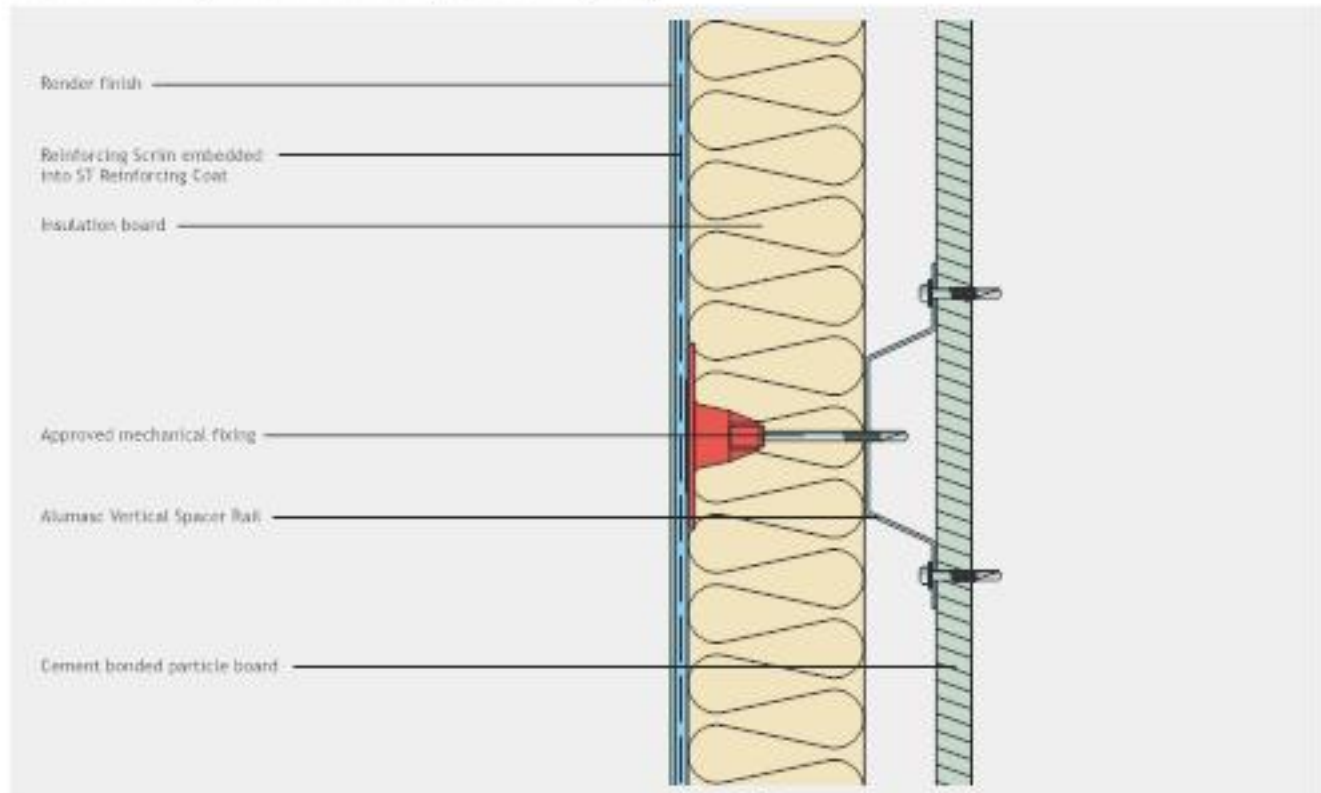

Swisrail base detail (section)

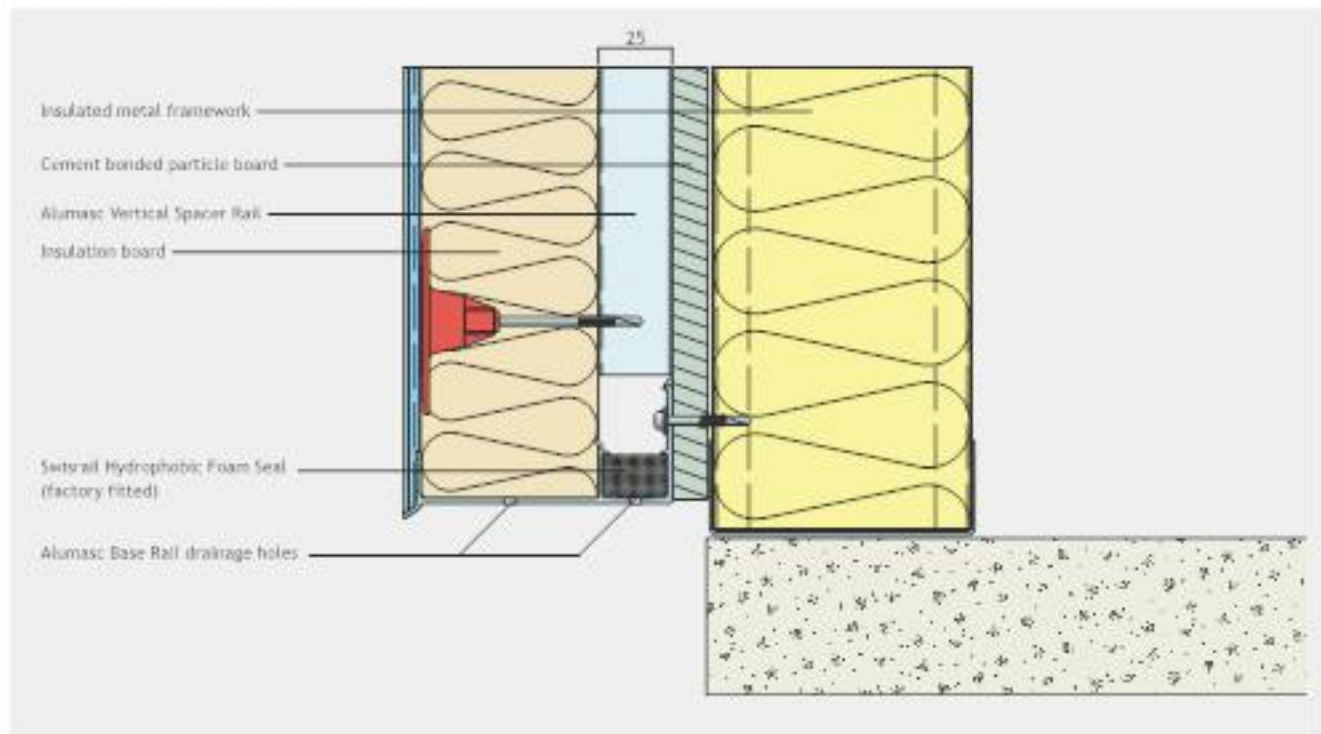

Swisrail - Application Details

Swisrail fire stop detail (section)

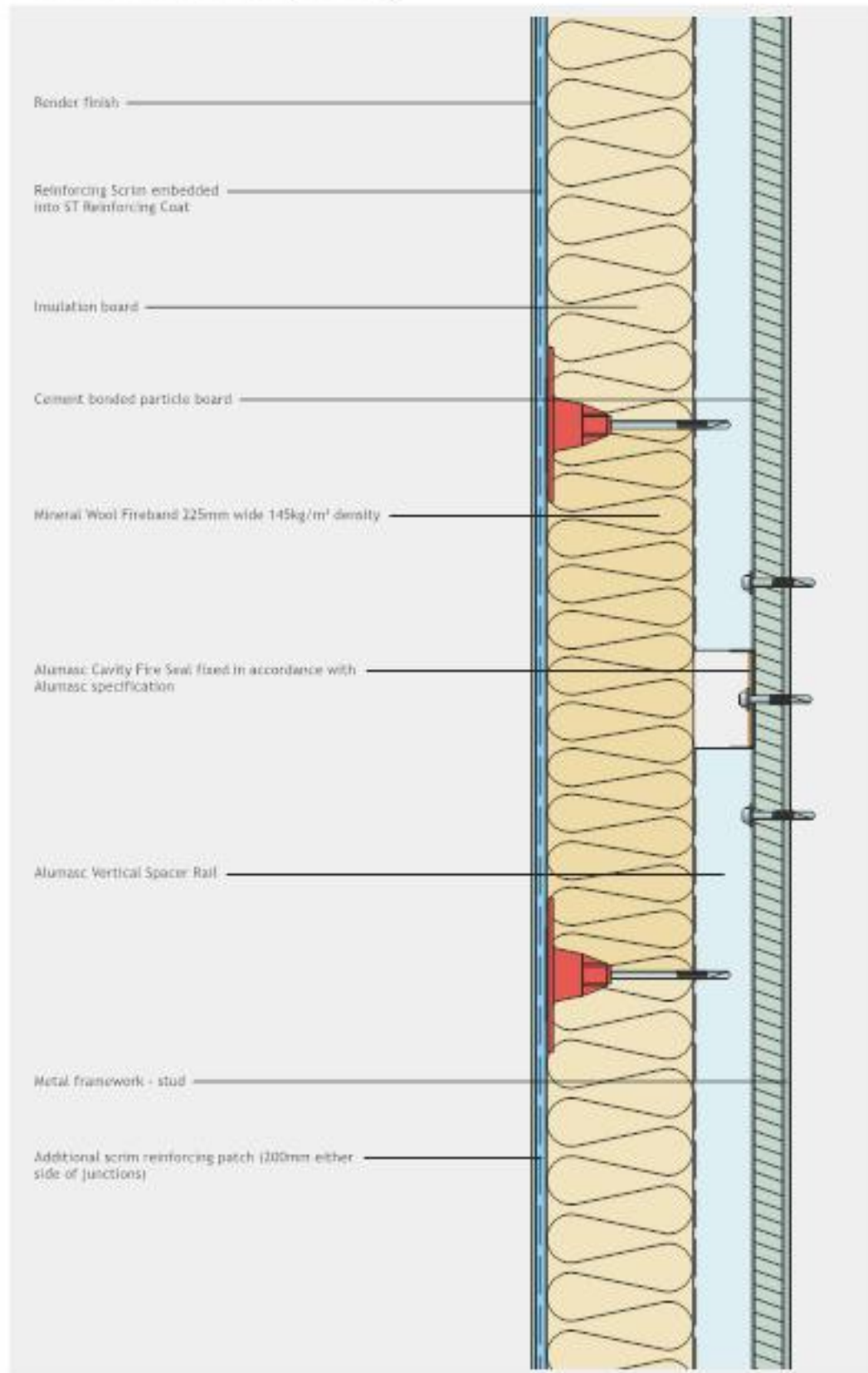

Swisrail - Application Details

Swisrail corner detail (plan)

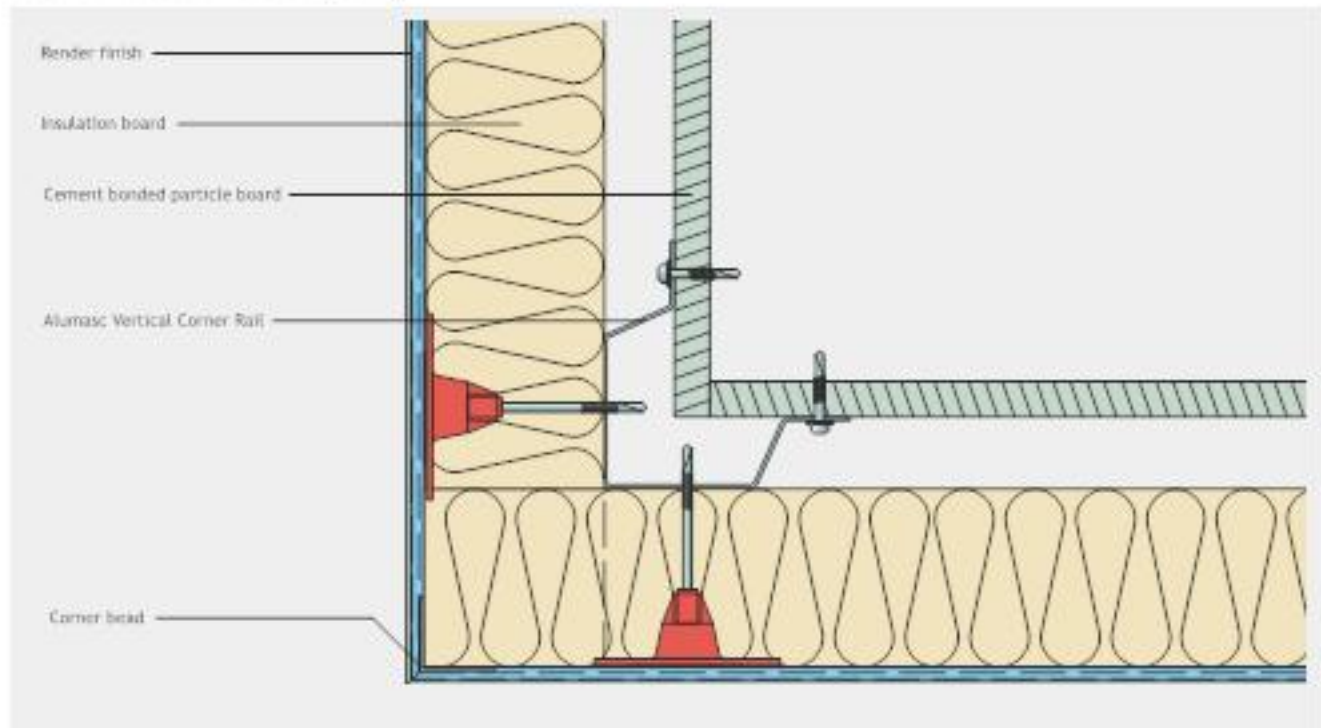

Swisrail window cill detail (section)

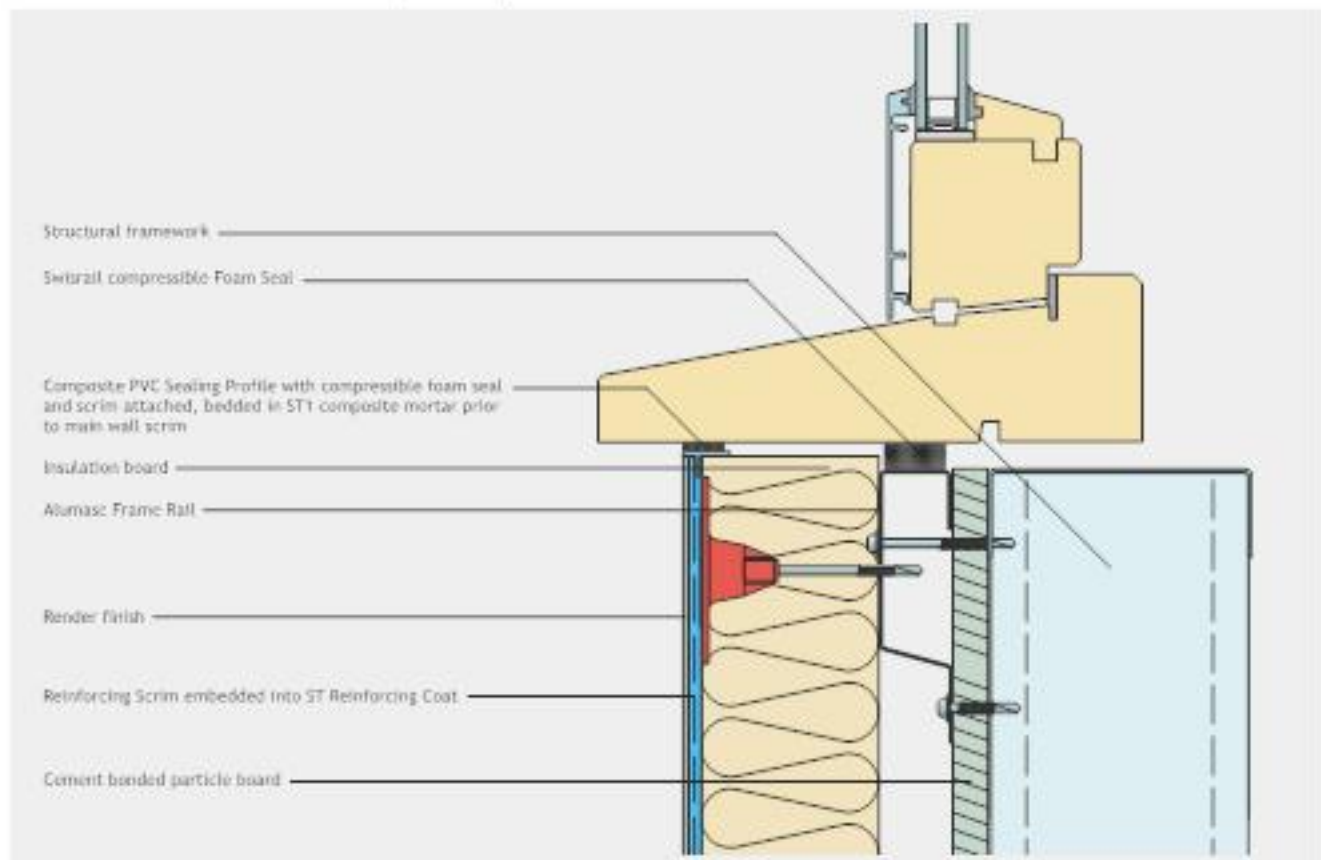

Swisrail - Application Details

Swisrail window jamb detail (plan)

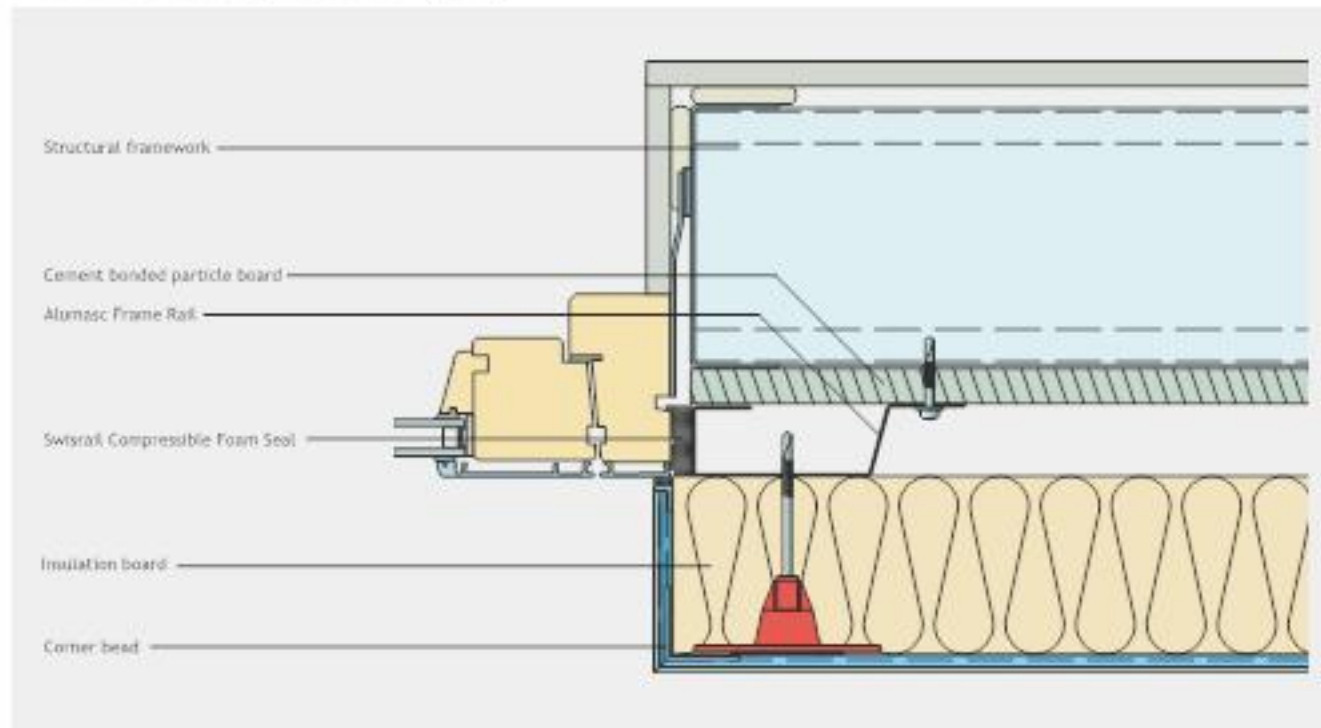

Swisrail window head opening detail (section)

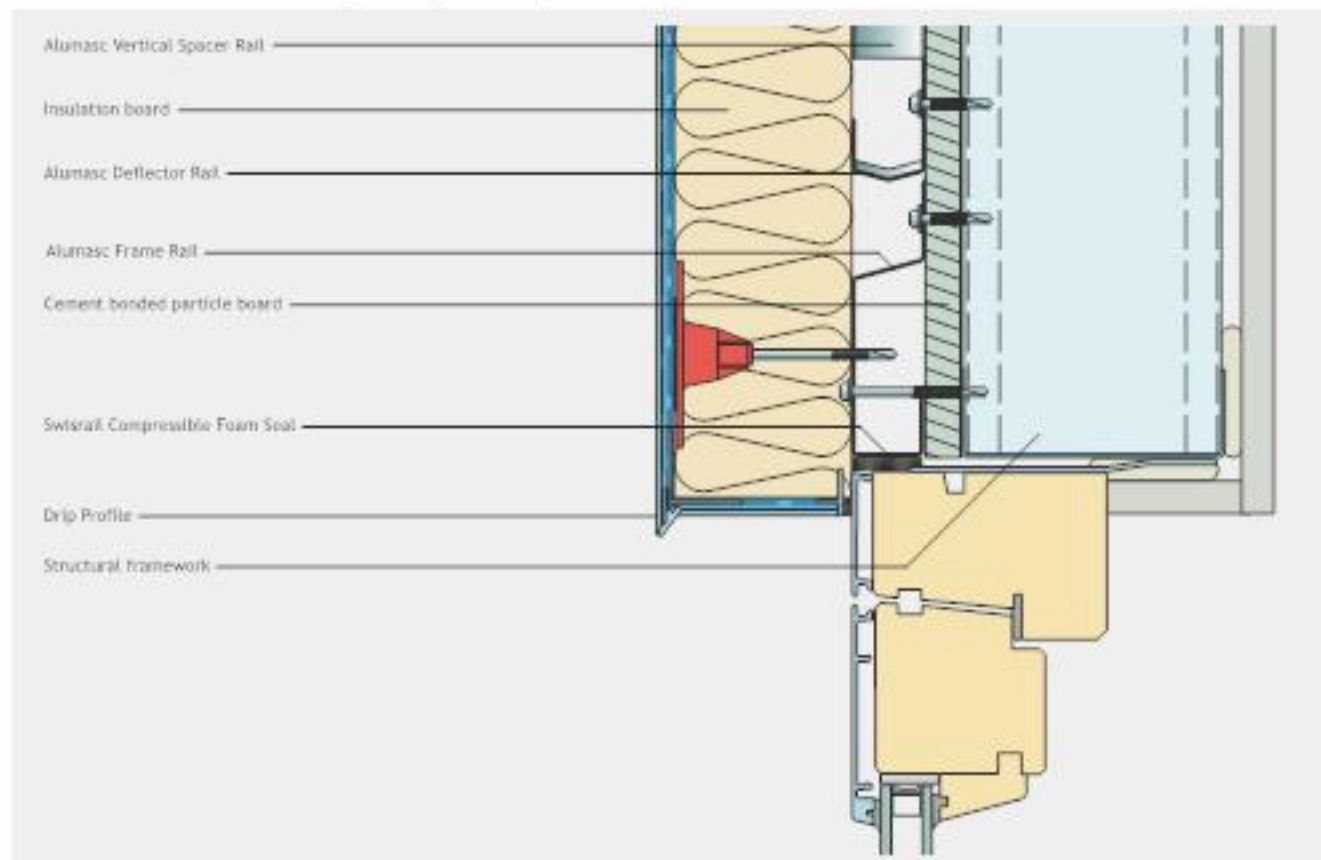

Swisrail - Layout and Fixing

Required Number and Arrangement of Fixings

All Swisrail fixing recommendations are subject to a site pull out test carried out by an Alumasc approved agent.

Because of varying wind pressure loads, more fixings will be needed in corner zones than in central surfaces, depending on the ground plan and the building height. The width of the corner zone 'R' depends on the building width 'a' (narrow side of the building).

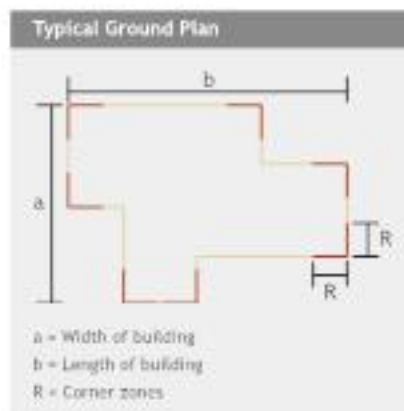

Swisrail Rail Layout

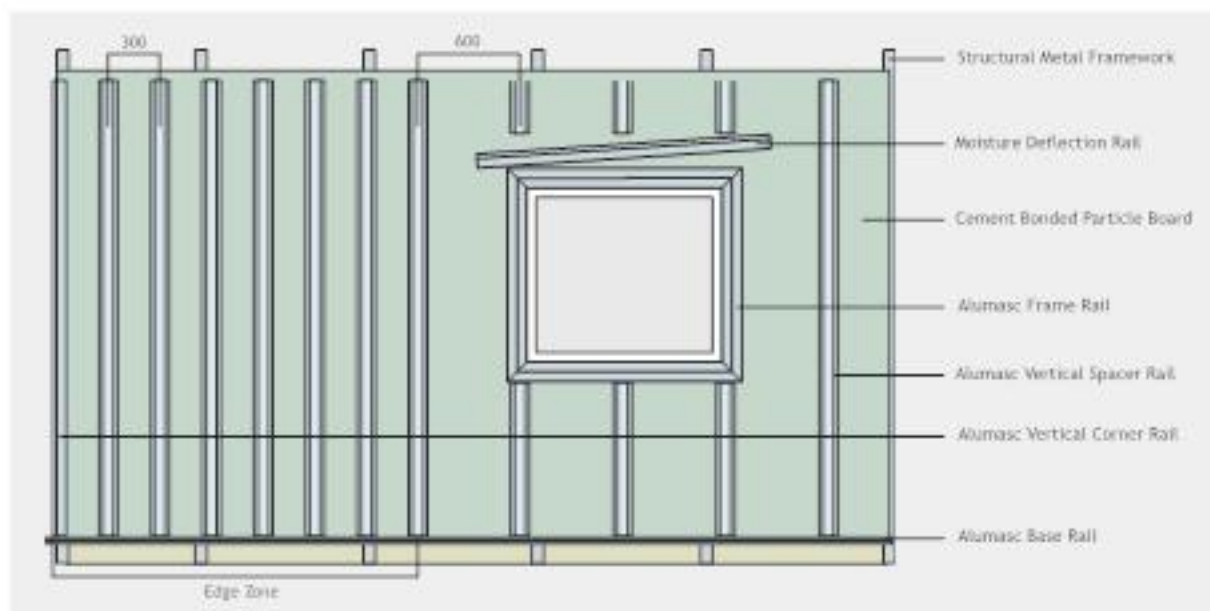

Swisrail - Layout and Fixing

Swisrail is suitable for applications up to 6 storeys, proposals for applications above this level are subject to project specific written approval and compliance with Alumasc's current High Rise Policy.

- In all cases an independent Structural Engineer must be appointed to advise on the suitability of the proposed external wall insulation system specification and detailing on the particular building
- Projects are subject to the following specification clause:
 'In preparing this specification we have assumed that the structure of the building to which it relates is absolutely sound and free from defects in all respects. We have not carried out or commissioned a structural survey of the building and recommend that you consider this course of action if you have not already done so.'

The width of the corner zone is at least 1m, with a maximum of 2m. However, the following values apply owing to the practicalities of the fixing arrangement:

Building width	Corner zone R
up to 9m	1.0m
9 to 13m	1.5m
over 13m	2.0m

Project specific fixing patterns will be supplied by Alumasc Technical Services.



Swisrail Insulation Board and Fixings Layout

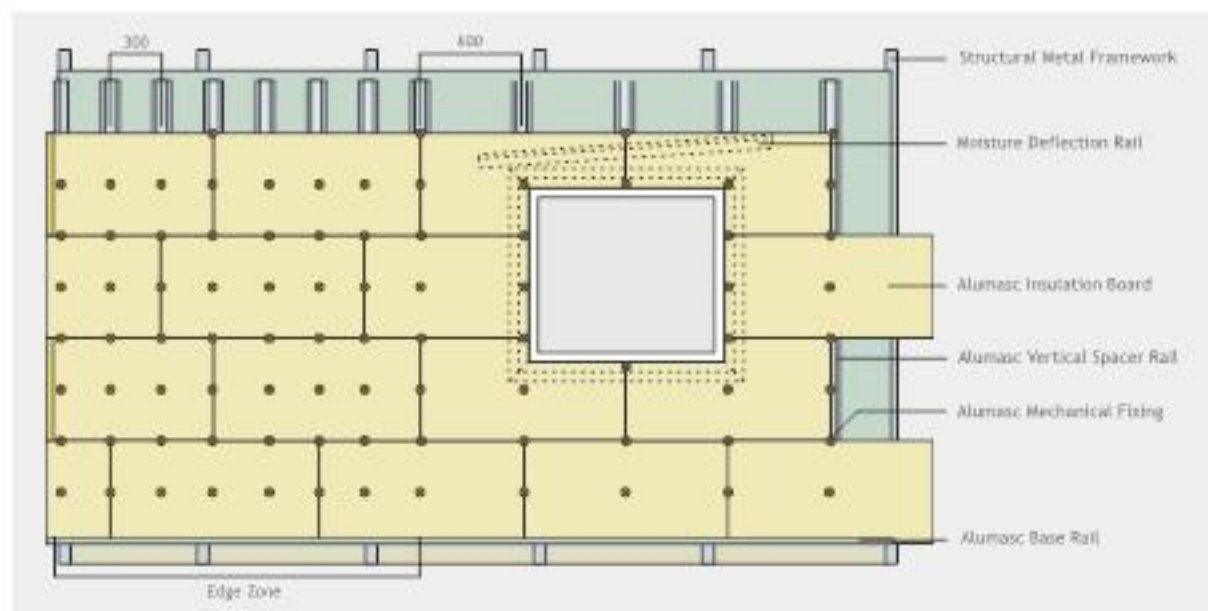

Alumasc Facades Project Gallery

Alumasc's BBA approved, fully warranted External Wall Insulation and Render systems offer optimum facade solutions for all types of building.

Alumasc has a proven track record of meeting project requirements for thermal performance, appearance, life expectancy and budget.



Alumasc Facades Project Gallery



Project Listing ■ The Wyvern Building, Bristol ■ Lynn Water Tower, Lynn ■ Centrium House, Woking ■ Lunar Rise, Plymouth ■ Tarlton Estate, London ■ Burbo Point, Crosby ■ Rakegate Primary School, Walsbyhampton

ST Silicone Render

The ST range of lightweight, through colour, Silicone renders are used as a contemporary finish to newbuild applications and the re-modelling of existing facades in both render only and external wall insulation applications. High performing Silicone renders are highly water-repellent, vapour permeable and weather resistant. Silkolitt Silicone finishes (rolled texture) are available in a wide range of colours.

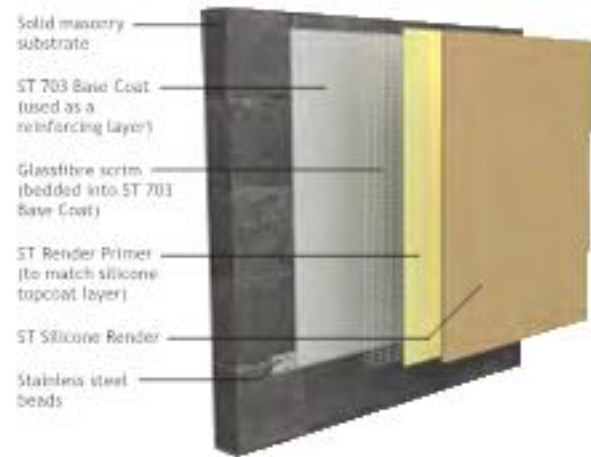

ST Silicone Render



Applications

- Contemporary finish for new build and remodelling applications
- Suitable for direct application to solid walls
- As part of an insulated render system - compatible with the Alumasc Swistherm, Swisrail, Swisslab and Swisspan External Wall Insulation Systems

Performance

- Fully weather resistant while remaining vapour permeable
- Manufactured under ISO 9001: 2008 and ISO 14001: 2004 Quality and Environmental Management systems
- Excellent durability and UV stable from a thin system build up
- Protects against damaging solvents, acids and pollutants in the environment
- Low susceptibility to soiling
- Highly resistant to impact damage
- Manufactured from high quality silicone resin and UV resistant colour pigments
- Rated Class 0 for surface spread of flame when used as part of an external wall insulation system, or applied directly to masonry substrate

Texture and Colour Options

- Silkolitt (rolled texture) - 1.5, 2.5 and 3.5mm grain sizes
- Wide choice of colour options

Installation and Maintenance

- Installed by approved specialist contractors
- Requires minimal routine maintenance



Topcoat Render Coverage

25 kg tub	Coverage
Silkolitt 1.5mm	Up to 8m ² per tub
Silkolitt 2.5mm	Up to 7m ² per tub
Silkolitt 3.5mm	Up to 5m ² per tub

Note: Thickness is predetermined by chosen grain size

Coverage rates stated are for guidance only and depend on background substrate and consistency of mix. Contractors should always verify the coverage rate according to the specific characteristics of each individual project and product.

ST Silicone Render

Textures

ST Silicone renders are available in a variety of finishes.

ST Silkolitt render offers a choice of three rolled finishes, creating an even textured appearance. The degree of texturing is determined by grain size within the render mix - finest using grain size 1.5, up to a heavier texture using grain size 3.5.

Rolled Texture Finishes



ST Silkolitt rolled texture finish grain size 1.5



ST Silkolitt rolled texture finish grain size 2.5



ST Silkolitt rolled texture finish grain size 3.5



ST Silicone Render

Colours

The Alumasc Colour System offers a wide range of colours, which are divided into seven sections - ie, yellows, blues, greens, etc. Within each section there are many variations of colour intensity from strong vibrant colours to subtle tones.

The Alumasc Colour System

The Alumasc Colour System is an exceptional colour modelling aid that assists designers in creating harmonised colour and texture schemes for buildings.

Colours are reproduced here for general guidance only. Please contact Alumasc for samples or colour chart. Alternatively, visit our website to use our interactive colour selector.



ST Mineral Render

Alumasc ST lightweight Mineral renders are used as a contemporary finish to newbuild applications and the re-modelling of existing facades. Natural Mineral renders are manufactured from natural material and are available as Mineral Render K (rolled texture) in white, and can be over painted with Alumasc Silicone Facade Paint.

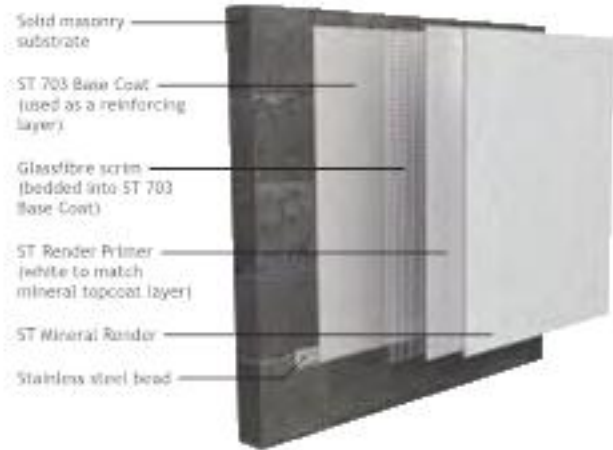

ST Mineral Render

Colours and Textures

Rolled Texture Finishes



Mineral Render K 2mm grain sizes



Mineral Render K 3mm grain sizes



Mineral Render K 4mm grain sizes

Topcoat Render Coverage

ST Mineral K Per Bag
2mm up to 12.5m ²
3mm up to 10m ²
4mm up to 7.5m ²

Note: Thickness is predetermined by chosen grain size.

Coverage rates stated are for guidance only and depend on background substrate and consistency of mix. Contractors should always verify the coverage rate according to the specific characteristics of each individual project and product.

Applications

- Contemporary finish for new build and remodelling applications
- Render system for direct application to solid walls
- As part of an insulated render system - compatible with the Alumasc Swistherm, Swisrail, Swisslab and Swisspan External Wall Insulation Systems

Performance

- Fully weather resistant while remaining vapour permeable
- Manufactured under ISO 9001: 2008 and ISO 14001: 2004 Quality and Environmental Management systems
- Excellent durability and UV stable from a thin system build up
- Highly resistant to impact damage
- Made entirely from natural materials (mineral aggregates, white marble grain)
- Non-flammable and Class 0 surface spread of flame

Texture and Colour Options

- Mineral Render K (rolled texture) in 2, 3 and 4mm grain sizes
- The base colour of ST Mineral Render is white. Should a coloured render be required, either specify ST Silicone Render as an alternative (see page 32), or overpaint ST Mineral Render with Silicone Façade Paint (see page 36)

Installation and Maintenance

- Installed by approved specialist contractors
- Requires minimal routine maintenance



Decorative Coatings - Silicone Façade Paint

Alumasc's Silicone Façade Paint has been developed specifically for use as a finishing coat over Alumasc ST Mineral Render, bringing the special benefits of a silicone-based coating to independent application over virtually any clean and sound substrate. Available in a wide range of colours, Alumasc Silicone Façade Paint has high weather resistance against driving rain, UV light and environmental pollution. It has excellent application properties with brush, roller or airless spray.



Decorative Coatings - Silicone Façade Paint

Sample Colours



Applications

- For use with Alumasc's ST Mineral Render and can be used with Alumasc's Swistherm, Swisrail, Swisslab and Swisspan External Wall Insulation systems
- Can also be used directly on in-situ or precast-concrete, concrete blockwork, brickwork, renderings, calcium silicate or fibre-reinforced cement
- For two coat application by roller or brush
- Can be spray applied where applicable

Performance

- BBA certified, when used as part of the Swistherm insulated render system with ST Mineral Render finish
- Manufactured under ISO 9001: 2008 and ISO 14001: 2004 Quality and Environmental Management systems
- Life expectancy in excess of 15 years
- When cured, provides a watertight finish that is vapour permeable
- Class D surface spread of flame

Colour Options

- Available in off white or in a base white which can be tinted in a wide range of colour options, matt finish

The Alumasc Colour System

The Alumasc Colour System is a colour modelling aid that assists designers in creating harmonised colour and texture schemes for buildings.

Colours are reproduced for general guidance only. Please contact Alumasc for samples or colour chart.

Alternatively, use our interactive colour selector on the website.



Silicone Façade Paint

15 Litre Drum	Coverage
Silicone Façade Paint	Approximately 0.2 - 0.25 litres per m ² per coat

Coverage rates stated are for guidance only and depend on background substrate and consistency of mix. Contractors should always verify the coverage rate according to the specific characteristics of each individual project and product.



Alumasc Project Support

Alumasc Technical Services can advise on all aspects of product selection, specification and integration of Alumasc systems into any building design.

Specific technical advice is always available through our Area Sales Managers, Site Support Technicians or Technical Services team.

The Alumasc Four Part Business Proposition

Based on an integrated delivery of the four key factors that make up a top class Facades system offer:



Premium Products

A constantly evolving range of quality proven world class products and systems, fully accredited to UK, European and USA standards.



Technical support

Comprehensive data for specification and use of all products and systems is available in published form, and on the company website.

This is backed up with proactive support on a project basis, led by specialist area managers and using the latest CAD technology.



Approved Contractors

A rigorously trained and monitored installation network for each specialist system to ensure correct application on site.



Warranties

A comprehensive choice of Alumasc warranties, giving protection for up to 20 years, with the additional option of a pre-paid insurance underwritten warranty, ensuring long term peace of mind.

Alumasc Technical Support for Facades

Design Support

- Detailed site evaluation and survey reports
- Design advice
- Cost estimates
- Project specific elevational colour schemes
- Thermal efficiency calculations
- Condensation risk analysis
- Wind loading calculation for high rise
- CAD details
- Product samples

Specification Support

- Detailed NBS specifications
- Advice on Regulations and Standards
- COSHH and product data sheets

Installation, Aftercare and Warranties

- Installation by an approved contractor network, on site technical and installation support, project specific warranties, supplementary maintenance schedules and programmes



Approved Contractors and Warranties

Alumasc have, as part of their support team, a UK network of fully trained and approved contractors available to price and carry out and install Alumasc EWI and Render systems for all types of new build and refurbishment projects.

Alumasc Approved Contractors

Installation of Alumasc EWI and Render systems is carried out by a national network of fully trained and approved contractors.

Alumasc Approved Contractors:

- Provide fully warranted workmanship as part of the Alumasc products and services warranty offer
- Undergo comprehensive training both in-house and on-site, with a register kept of all carded operatives within the company
- Are assessed for competence and suitability on specific project types prior to selection for tendering opportunities
- Are assessed for financial stability prior to any award of approved status
- Are prepared to work beyond their local geographical boundaries where possible, therefore enabling provision of a list of contractors tailored to your individual need
- Are monitored as part of the ISO 9001: 2008 Quality Management and ISO 14001: 2004 Environmental Management systems

Alumasc ensure approved contractors receive valuable, hands-on assistance in the application of all Alumasc products and systems, as well as refresher training, whenever required, to ensure that applicators are all aware of any product or method improvements.

For details of the Alumasc approved contractor network please contact us or your local area sales manager direct.

Warranties

Alumasc offers a comprehensive choice of warranties covering both product and installation to suit the specified design life of the installed product.

- Alumasc backed warranties are available for 10 or 15 years supported by public and product liability insurances with a total indemnity limit of £50 million on an annually renewable basis
- Alumasc can also arrange third party insurance backing giving up to 20 years cover subject to independent final inspection, documented compliance with an agreed maintenance schedule and pre-payment of the relevant premium

NB: Warranties are only offered on Facades projects that have been installed by an Alumasc Approved Contractor, in accordance with the relevant project specification and Alumasc Quality Assurance scheme ruling at the time of application

For all information relating to warranties for your specific project please contact us at the St Helens office or your local Area Sales Manager direct.



Swistherm - Installation and Fixing

Preparation

1 The Swistherm system should be installed on a sound substrate. Uneven surfaces should be dubbed out with M.R. S3 Dubbing Render.

Before installing insulation boards, apply self-adhesive 20/3 EWI Sealing Tape to all junctions between the Swistherm system and other materials - eg, window/door frames. Alternatively, install Sealing Profiles with a peel-off protective strip.

Fixing the Base Bead

2 Mark the position of the base board with a chalk line. Fix the bead to the wall with hammer-set screws at 300mm centres. Use packing shims where necessary to ensure a straight, even line.



4 Drill through the insulation boards into the substrate, to the fixing patterns shown on pages 18-19.



5 Use approved Impact Plug/Screw Fixings and Washer fixings to secure the insulation boards. Make sure that the plugs are flush with the insulating boards.



Fixing the Insulation Boards

3 Apply mortar to the back surface of each board, as specified by Alumasc.

Press the boards in place, in a breaking bond pattern, tightly butt jointed. Check that the boards are level, with no protruding edges, and remove any excess mortar from joints.



6 At building corners, neatly cut back all edges of protruding boards to a straight edge. Grind board edges to ensure complete alignment.



Swistherm - Installation and Fixing

Joints and Connections

7 Use Swistherm Expansion Joint Profiles at all expansion joints in the building structure to form a joint approximately 15mm wide. Ensure the open joint is kept free of mortar by temporarily filling with a polystyrene strip.

8 Secure external corners by embedding the glassfibre mesh wings into a layer of ST1 Composite Mortar prior to rendering.



Reinforcement

9 A 250 x 500mm piece of reinforcing scrim should be bedded into a layer of ST1 Composite Mortar at all corners of window and door openings, and then covered with a further mortar layer.



10 Apply either a thin-coat or thick-coat mortar reinforcement over the whole wall surface. Apply Reinforcing Scrim in rows, lapping joints 100mm, and press into the mortar. Lay mesh around corners and into window reveals. Flatten and smooth the mortar extruding through the mesh, completely covering the mesh.



11 Allow the reinforced base coat to dry out for about 8 days before applying the render topcoat.

Silicone Render Finish

12 Apply a thick coat of Alumasc ST Primer in the colour shade of the top coat.



13 Apply the ST Silicone Render with a stainless steel smoothing trowel in the thickness of the grain and rub with a plastic float to achieve the desired effect.



14 Silicone Renders can also be applied with a conveying pump with spraying equipment. ST Silkolitt dries naturally by water evaporation; the drying time may be affected in high air humidity and/or low temperatures.

Swisrail - Installation and Fixing

Preparation

The Swisrail system should be installed on a sound substrate.

Before installing insulation boards, apply self-adhesive 20/3 EWI Sealing Tape to all junctions between the Swisrail system and other materials eg. window/door frames.

Alternatively, install Sealing Profiles with a peel-off protective strip.

Fixing the Base Bead

1 Mark the position of the base board with a chalk line. Fix the bead to the wall with hammer-set screws at 300mm centres. Use packing shims where necessary to ensure a straight, even line.



Fixing the Rails and Insulation boards

2 Fix rail system back to substrate at specified centres to form cavity.



3 Position boards in place, in a breaking bond pattern, tightly butt jointed. Check that the boards are level, with no protruding edges.



4 Drill through the insulation boards into the substrate, to the fixing patterns shown on pages 18-19.



5 Use approved EWI System Impact Plug/Screw Fixings and Washer fixings to secure the insulation boards. Make sure that the plugs are flush with the insulating boards.



6 At building corners, neatly cut back all edges of protruding boards to a straight edge. Grind board edges to ensure complete alignment.



Swisrail installation procedures continue as Swistherm steps 7 - 14.

Maintenance Advice

Alumasc External Wall Insulation systems are highly resistant to impact damage and are low maintenance. If damage is sustained, through vandalism or accident, Alumasc renders and coatings are easily repairable. Alumasc offers a comprehensive technical support and aftercare service for advice and assistance.

Suggested Maintenance Schedule

Render repairs and remedial work

Mechanical or other damage to the render surface must be repaired with Alumasc products and be applied by an Alumasc approved contractor in accordance with Alumasc specification and written guidelines.

If it is found that remedial or maintenance work is thought necessary please contact the original approved contractor and/or the Alumasc Area Sales Manager for your area. Where work has been warranted always check with Alumasc that the proposed remedial work would not invalidate any warranties.

Care must be taken to avoid discolouration of existing render system and coatings. All health & safety regulations must be adhered to at all times.

Cleaning

Regular cleaning of Alumasc's Lightweight ST Render system is to be undertaken in conjunction with the main building maintenance document, and is recommended as good practice to improve the life span of Render finishes and Façade Paints, but this is not a requirement of the Alumasc warranty.

To keep ST Lightweight Render systems and Façade Paints in optimum condition it is recommended that inspections take place on an annual basis and cleaning is actioned approximately every 5 years.

Leaks or stains

Suitable remedial action must be taken at the first opportunity when there is evidence of leaks or stains on the render system face these may originate from external sources and/or building details.

In the event of specific staining, the intensity of cleaning solution, beginning with hot soapy water, is to be increased until the required effect is achieved. A proprietary brick cleaning product may be used in specific circumstances.

Where appropriate, good architectural detailing should be promoted to ensure that water sheds evenly and effectively to prevent moisture streaking or stains.

Overpainting

ST Lightweight Render systems may be over-painted using ST Silicone Façade Paint, dependent upon dirt, environment, aesthetics and/or budget - after 8, 10, 12, 15, 20, 25 years etc. (Requirement is subject to the exposure of the building and location). Please consult Alumasc for technical advice.

ST Silicone Façade Paint will remain effective for 15 years but it would be advisable from the 10 year period onwards for (typically annual) visual checks to take place of significant components, main wall elevation, movement joints, etc as part of the maintenance regime in conjunction with other external building materials.

ST Façade Paints should be used for maintenance and should be applied strictly in accordance with the manufacturer's recommendations. Materials may be obtained from Alumasc. Please consult Alumasc for technical advice.

Gutters, downpipes etc

Ensure all gutters, downpipes, overflows etc are maintained in sound, clean condition. When damage and/or a blockage is reported, it is recommended that immediate action is taken to effect a repair or replacement. A continuous leak onto an ST Lightweight Render system or ST Façade Paint could cause staining or damage to the finish causing a secondary maintenance problem.

Movement joints

All Alumasc movement joints within the system should be inspected on a periodic basis in conjunction with the main maintenance schedule for any cleaning necessary, checking of seals and the removal of any obstructions.

Silicone sealants

All silicone sealants should be inspected and maintained on a periodic basis and appropriate remedial action taken to replace once the expected life of sealant has been reached.

Plants and landscaping

Project site conditions can affect the long term condition and subsequent maintenance of the ST Silicone Façade Paint. All external shrubbery, plants and landscaping must be kept in good order, and overgrown plants, etc should be cut back regularly to prevent algae/cides and or mildew from growing on the surface of the coating. ST Silicone Façade Paint has inbuilt fungicides and algae/cide agents but care must be taken to prevent excessive mould growth.

External fixtures

Any subsequent attachments and/or external fixtures fixed to the surface to the system must be installed in accordance with Alumasc specification requirements using approved mechanical fixings.



System Components

The following is a summary of useful information. Full details are available on the Alumasc Facades website.

Basecoats and adhesives



ST1 Composite Mortar

Dual purpose lightweight basecoat used as an adhesive and reinforcing layer. For use with Silicone and Mineral Render applications and with Swisstherm and Swisrail EWI systems.

ST Adhesive Mortar

Economic, lightweight mineral adhesive mortar for Swisstherm insulation slabs.

ST Dispersion F Adhesive

Ready-mix adhesive to ply and wood-based substrates. For use with the Swisstherm EWI system when adhesive-fixing the system to continuous plywood and timber substrates.

Insulation



Mineral Wool

HCFC and CFC-free. The only listed insulant classified as non-combustible. Also performs well as an acoustic barrier. Use with the Swisstherm, Swisrail and Swislab EWI systems.

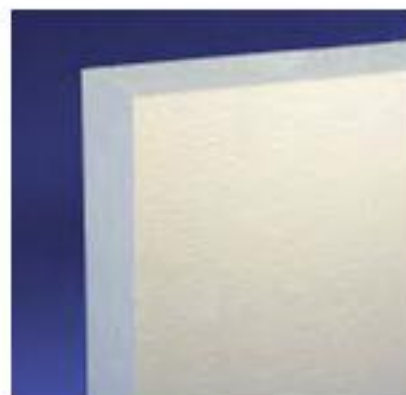

Polystyrene/FRA Grade EPS

HCFC and CFC-free. Lightest in weight of the listed insulants for a given thermal performance. Economic and easy to handle product for all types of building. Use for Swisstherm, Swisrail, Swislab and Swisspan EWI systems.



Cork

HCFC and CFC-free. Composed entirely of natural materials in both source and manufacture. 100% recyclable. Use with Swisstherm, Swisrail, Swislab and Swisspan EWI systems.



Phenolic (K5 EWB)

HCFC and CFC-free. High thermal performance, providing best U value of the listed insulants for a given board thickness. Use with the Swislab and Swisspan EWI systems.



Polyisocyanurate (PIR)

HCFC and CFC-free. A highly durable alternative to Phenolic, with which it shares key features, but with slightly increased thickness for a given U value. Use with the Swislab and Swisspan EWI systems.

Insulation materials

Insulation	Units	Mineral Wool	Polystyrene FRA	Cork	Phenolic (K5 EWB)	Polyisocyanurate (PIR)
Thermal conductivity	W/mK	0.036	0.037	0.038	0.020 to 0.022	0.026 to 0.028
Compressive strength	KN/m ²	65	70	140	150	150
Water vapour resistance	MN s/g	5.2	300	37.5	15	15
Fire performance	-	Non-combustible	Euroclass E	Euroclass E	UK Class 0	UK Class 0
Board density	Kg/m ³	140	16	105 and 120	50	32
Size	mm	1200 x 600	1200 x 600	1000 x 500	1200 x 480	1200 x 600
Thickness	mm	40 to 200 in 10mm increments	20 to 200 in 10mm increments	40 to 100 in 10mm increments plus 75 and 150	20 to 120 in 10mm increments	20 to 120 in 10mm increments

System Components

Reinforcement

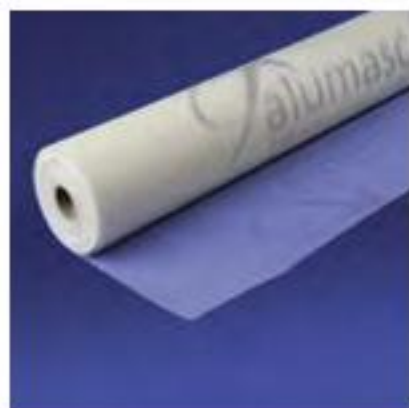

Scrim Reinforcement

Alkali-resistant glassfibre woven fabric mesh used as reinforcement in all Alumas EWI and render-only systems. Acts to prevent cracking of the render top-coat. Use for render-only applications, and with the Swisitherm, Swisrail, Swisslab and Swisspan EWI systems.



ST1 Composite Mortar (used as an adhesive)

Dual purpose, lightweight basecoat material used as an adhesive and reinforcing layer. Use with Silicone and Mineral Renders applications, and with the Swisitherm and Swisrail EWI systems.

Beads and Fixings

Aluminium Beads

Use only with gypsum renders, or protect the beads with an appropriate resistant finish. For use with Silicone and Mineral Render systems, and with Swisitherm and Swisrail EWI systems.

Powder Coated Galvanised Steel Beads

Use only with cement-based renders, and must not be cut or trimmed to suit on site. For use with Polymer Render systems, and Swisslab and Swisspan EWI systems.

Powder Coated Galvanised Steel Beads with pvc nosing

Use only with cement-based renders. For use with Polymer Render systems, and Swisslab and Swisspan EWI systems.

Stainless Steel Beads

Use only with cement-based renders. Can be trimmed on site using metal shears or fine-tooth saw. For use with Polymer Render systems, and Swisslab and Swisspan EWI systems.

PVC Beads

Available for use as an alternative for all systems. Please consult Alumas for technical advice.

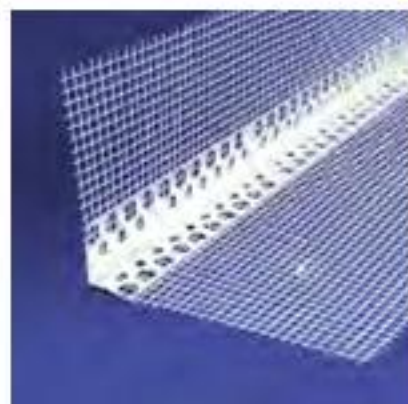

Renderers and Coatings



Silicone Render - ST Silkolitt

Contemporary, high-performance render finish, suitable for use as part of an insulated render system and as a render-only system for direct application to solid walls. Use with Swisitherm, Swisrail, Swisslab and Swisspan EWI systems.

ST Mineral Render - Mineral K

Contemporary, eco-friendly render finish, suitable for use as part of an insulated render system and as a render-only system for direct application to solid walls. Use with Swisitherm, Swisrail, Swisslab and Swisspan EWI systems.



ST Primer Coat

A primer coat for most common plasters and substrates, used for render-only application or as part of an insulated render system. Use with Swisitherm, Swisrail, Swisslab and Swisspan EWI systems.

ST 703 Base Coat

Lightweight, mineral base coat for use with ST Silicone decorative topcoats.

ST Additive L

Setting accelerator for use with ST Silkolitt and ST Silkorill silicone renders to assist with water curing times.

ST Silicone Façade Paint

A powerfully water-repellent facade paint for use as a finishing coat over Alumas ST Mineral Render. Also suitable for application on in situ or precast concrete, concrete blockwork, brickwork, renderings, calcium silicate and fibre-reinforced cement.

Alumasc Premium Products - All Brands

Alumasc provides an unrivalled range of premium products for building exteriors and drainage, along with high levels of technical expertise and project support. Our wealth of experience combined with networks of approved installers, merchant stockists and a choice of warranty options ensures we provide appropriate product and system solutions for all types of buildings.



Alumasc is the UK's leading manufacturer of aluminium rainwater systems and offers a complete range of gutters, downpipes and fascia/soffits for both contemporary and traditional architecture.

Alumasc's cast iron rainwater system is for historic and restoration sites, with bespoke designs available to match or replace existing installations.

Rainwater

- Aluminium Rainwater Systems
- Aluminium Fascias, Soffits and Copings
- Cast Iron Rainwater Systems

www.alumascrainwater.co.uk



Alumasc's Harmer brand provides market leading solutions for rainwater handling and building drainage.

Aluminium roof, floor and shower drains are complemented by specialist drainage ranges in plastic. A choice of cast iron pipework systems is available for internal and rainwater drainage. Specialist rainwater management systems and paving and deck supports are also available.

Drainage

- Roof, Floor and Shower Drains
- Cast Iron Soil & Waste Systems
- Rainwater Management Systems
- Paving and Decking Supports

www.alumascdrainage.co.uk



Alumasc is a specialist provider of world class waterproofing and green roof systems.

The range includes Derbigum high performance flat roof membranes, Firestone TPO and EPDM single ply membranes, Hydrotech structural waterproofing and ZinCo Extensive, Biodiverse, Semi-intensive and Intensive green roofs.

Waterproofing

- Flat Roof Membranes
- Single Ply Membranes
- Structural Waterproofing
- Green Roof Systems

www.alumascwaterproofing.co.uk



Alumasc is a specialist in the design and development of thermally efficient insulated render systems. Alumasc's external wall insulation systems are available with a choice of insulating material and silicone, mineral or polymer-modified decorative render finishes.

Facades

- External Wall Insulation
- Render Only Systems
- Brick Slips & Specialist Systems
- Decorative Coatings

www.alumascfacades.co.uk

Alumasc Project Gallery - All Brands



Wimbledon Centre Court, Skyline



Burbo Point Apartments, Swisrail EWI

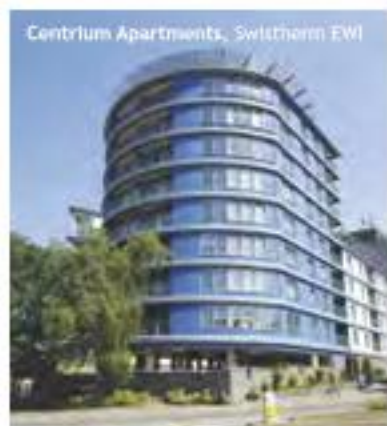

Centrium Apartments, Swissthorn EWI



Derby Hospital, Harmer SML



Harris Academy, Derbigum



Tate Modern, Hydrotech



Millennium Stadium, Harmer SML



Waterstone Park, Skyline & GX



River Quarter, ZinCo Green Roof; Hydrotech



St Pancras Station, Apex Heritage Cast Iron

Alumasc Facades for Refurbishment

Alumasc also specialises in External Wall Insulation and Render systems for refurbishment applications. Ever-higher thermal performance standards and current urban regeneration methods have influenced the way energy expenditure of our building stock is reduced whilst improving weathering and aesthetic characteristics. Consequently, the specification of external wall insulation for refurbishment projects is increasingly used for extending the life of existing buildings.



Swisslab External Wall Insulation

Swisslab is the market leading insulated render system for overcladding existing properties. It is extensively used to upgrade social housing in order to meet the "decent homes standard" and strongly contributes to urban regeneration. Insulation materials are mechanically fixed direct to a continuous substrate and are faced with M.R. Polymer modified renders for a traditional appearance, or lightweight Silicone or Mineral renders for a more contemporary look.

Applications

- Refurbishment - where structure provides continuous support for insulation slabs
- Construction types - primarily suited to refurbishment applications
- Buildings up to 6 storeys - suited for unrestricted use
- High rise applications - suitable subject to Alumasc's high rise policy

Performance

- BBA approved, fully warranted system with life expectancy in excess of 30 years
- Manufactured under ISO 9001: 2008 and ISO 14001: 2004 Quality and Environmental Management systems
- Fully weather resistant whilst remaining vapour permeable
- Allows the fabric of the building to act as a heat store, increasing thermal efficiency
- Eliminates cold bridging, condensation and mould growth
- Improves external appearance of building



Alumasc Facades for Refurbishment

Swisspan External Wall Insulation

Swisspan is an insulated render system for building refurbishment. It is used for the overcladding of buildings where mechanical fixing is problematic and for uneven substrates. Insulation is mechanically fixed to galvanised steel support rails that span between the structural elements, and then faced with M.R. Polymer modified traditional renders, or lightweight Silicone or Mineral renders.

Applications

- For building refurbishment where the structure does not provide continuous support for the insulation
- Ideal for problematic substrates or uneven modelling applications

Performance

- BBA approved, fully warranted system with life expectancy in excess of 30 years
- Manufactured under ISO 9001: 2008 and ISO 14001: 2004 Quality and Environmental Management systems
- Fully weather resistant while remaining vapour permeable
- Integrated rail system provided secure fixing and load transfer to loadbearing elements of the structure
- Rated Class 0 for surface spread of flame



Polymer Dash and Plain Renders

M.R. 57 is a premium, one coat polymer cement dashing render, available in seven standard colours, complemented by a wide choice of aggregates dash finishes.

M.R. 54 is a two-coat plain render system, ideal for coating large elevations and for creating feature bands on building facades.



Masonry Paint

M.R. 56 Masonry Paint is a high performance coating that produces a smooth, durable finish when applied to virtually any dry, clean and solid background. It is suitable for use over brick/blockwork, precast concrete, rendered or pebble-dashed.



Rendabrick and Brick Slips

Alumasc manufactures and supplies a range of specialist cladding, developed to work in conjunction with its BBA certified EWI systems. These facade treatments include M.R. Rendabrick and Alumasc's Traditional Brick Slips.



To get a copy of the Alumasc Facades for Refurbishment Brochure Ring +44 (0) 1744 648400, or go to www.alumascfacades.co.uk

ALUMASC

INSULATED RENDERS

- Rainwater
- Drainage
- Waterproofing
- Façades

Technical Support

+44 (0) 1744 648400

Literature Hotline

+44 (0) 808 100 2008

Website

www.alumascfacades.co.uk

ALUMASC EXTERIOR BUILDING PRODUCTS LTD

White House Works, Bold Road, Sutton,

St Helens, Merseyside, WA9 4JG

United Kingdom

Telephone: +44 (0)1744 648400

Facsimile: +44 (0)1744 648401

Website: www.alumascfacades.co.uk

E-mail: info@alumasc-exteriors.co.uk

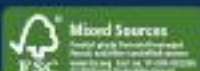

All reasonable care has been taken in the preparation of this brochure, all information, recommendations and guidance notes on the use of The Products are made without guarantee since the conditions of use are beyond the control of Alumasc Exterior Building Products Limited (The Company). The customer is responsible for ensuring that each product is fit for its intended purpose and that conditions for use are suitable. The information contained in this brochure and advice arising therefrom is free of charge and accordingly on the terms that no liability or liability for negligence will attach to the Company or its servants in relation to any such service arising out of or in connection with this brochure. The Company pursues a policy of constant product development and information contained in this publication is therefore subject to change without notice.

1011/2K

alumasc
EXTERIOR BUILDING PRODUCTS