

Gable Features

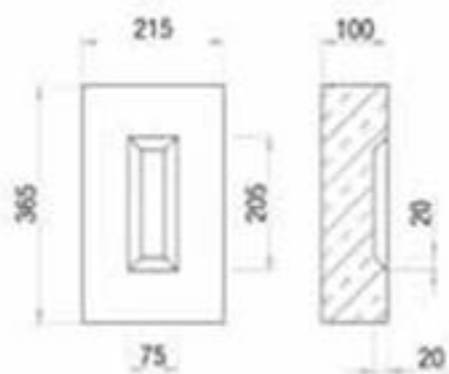

GV1



Weight: 17Kg

GV2

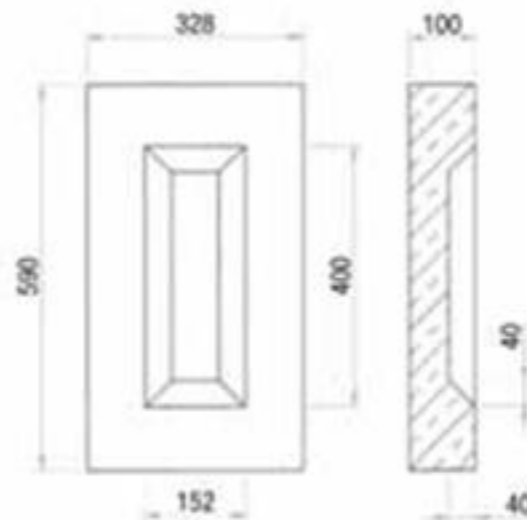

Weight: 36Kg

GV3

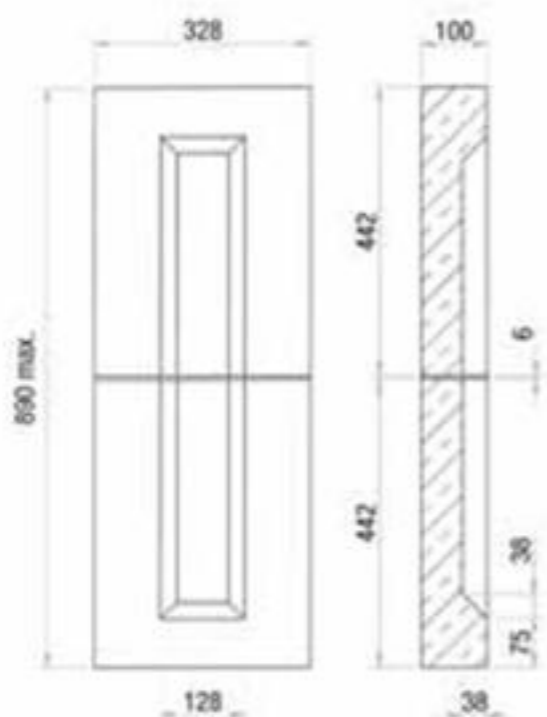

GV4

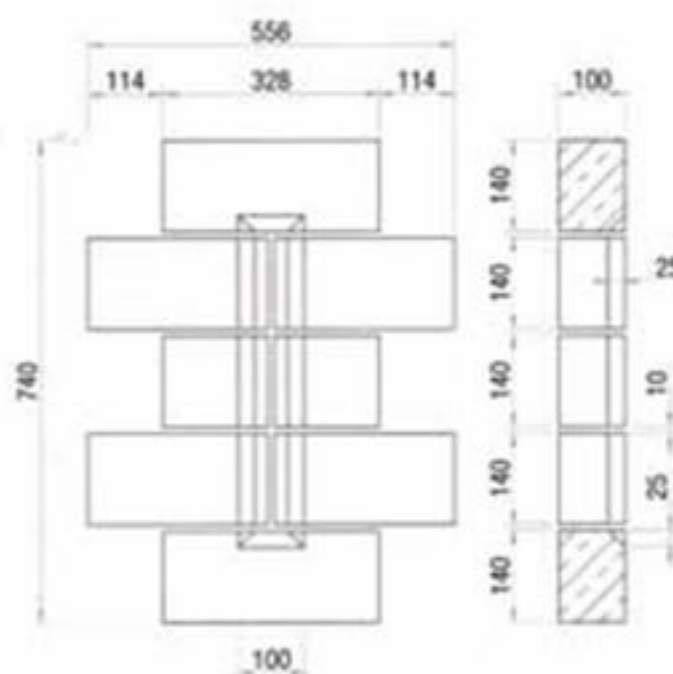

Weight: 60Kg



Obelisks

OB1

OB2

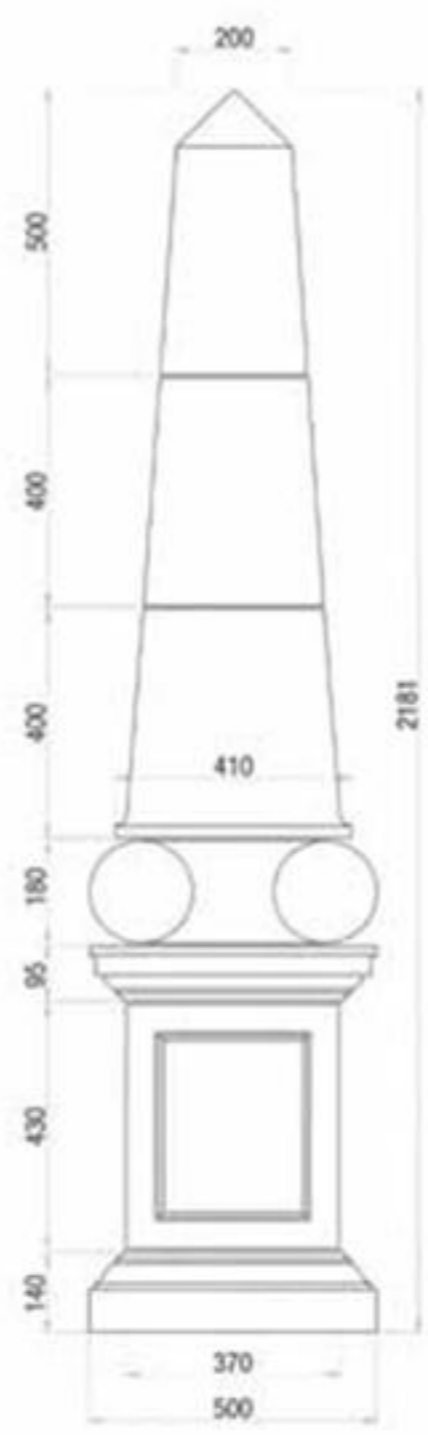

Total Weight: 460Kg

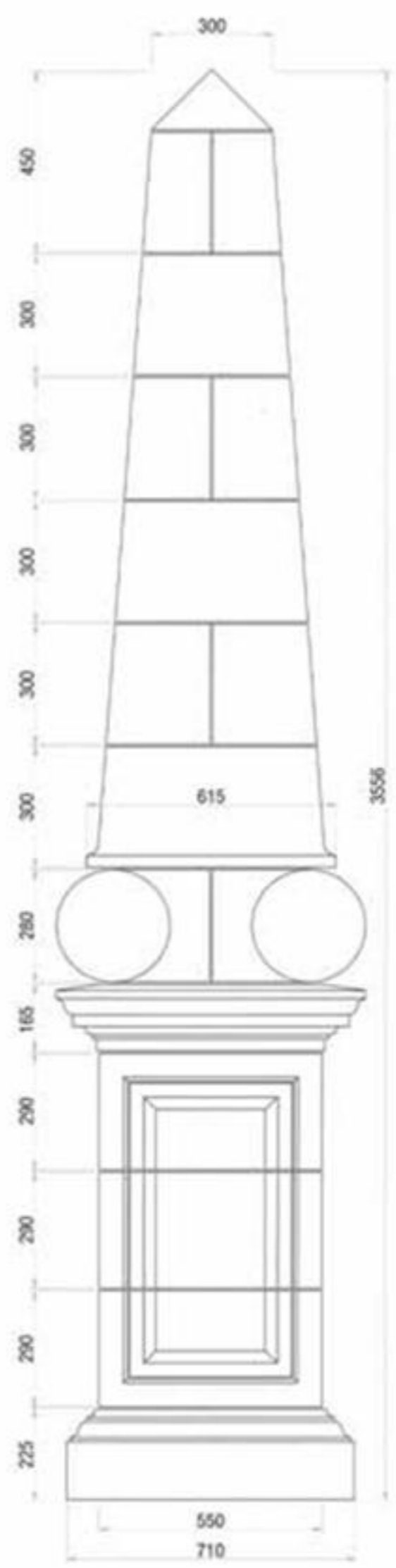

Total Weight: 1600Kg

Chimney Caps



These units are designed for insitu flaunching with concrete and the stones should be tied into the surrounding brickwork and/or concrete flaunching by means of mechanical ties.

Please specify dimensions 'A' and 'B' when ordering.

X90R

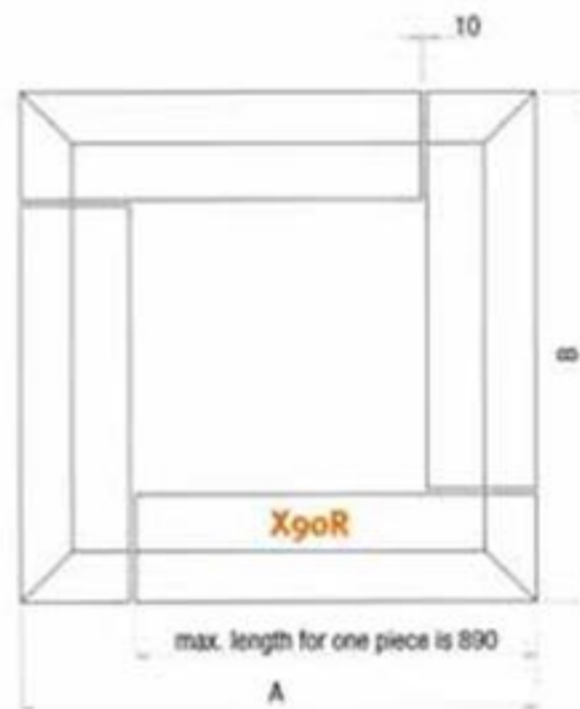

SC

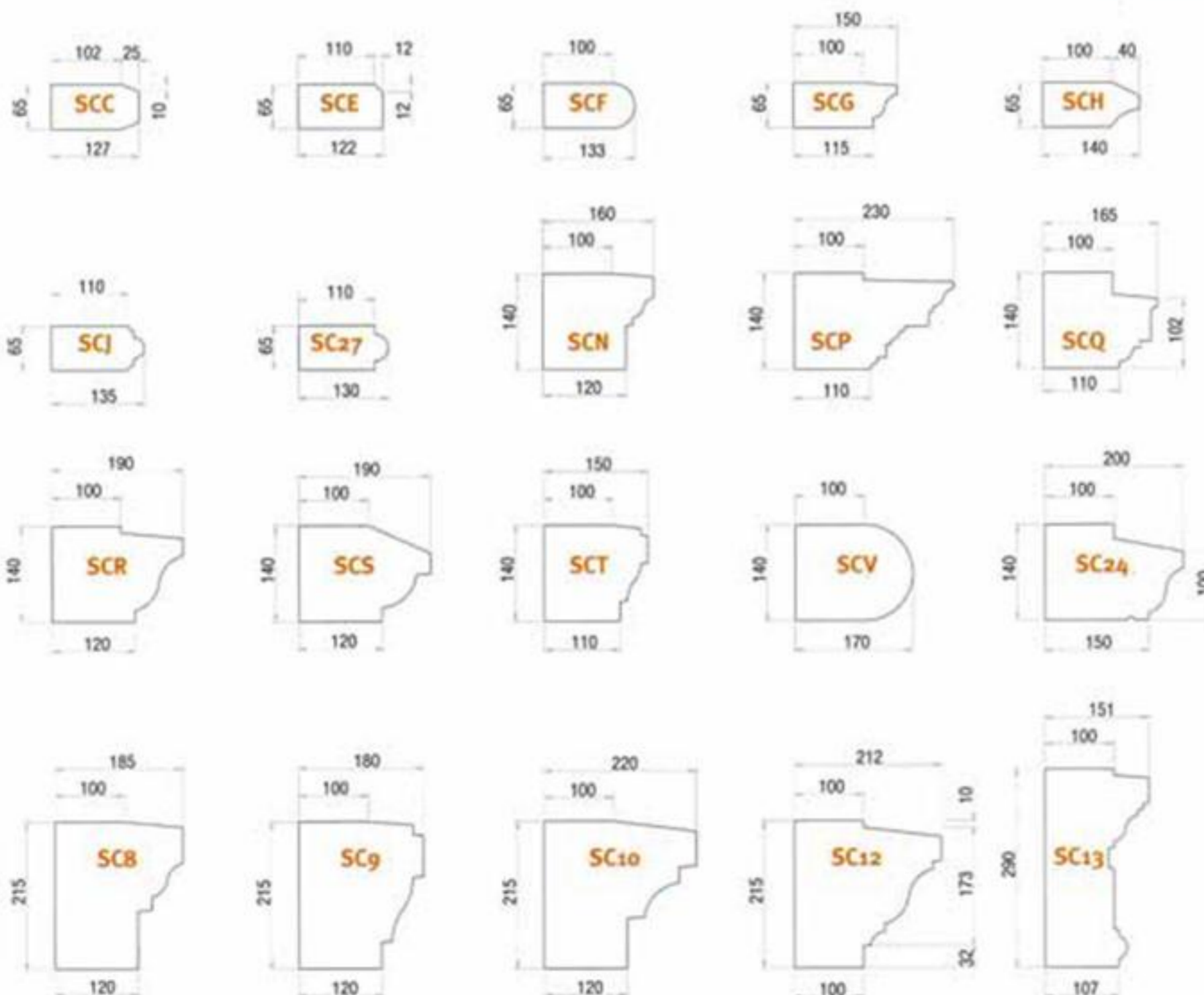



Pier & Pedestal Bases

Weights are shown in Kg/m. Please specify dimensions 'A' and 'B' when ordering.

X90L

X90R

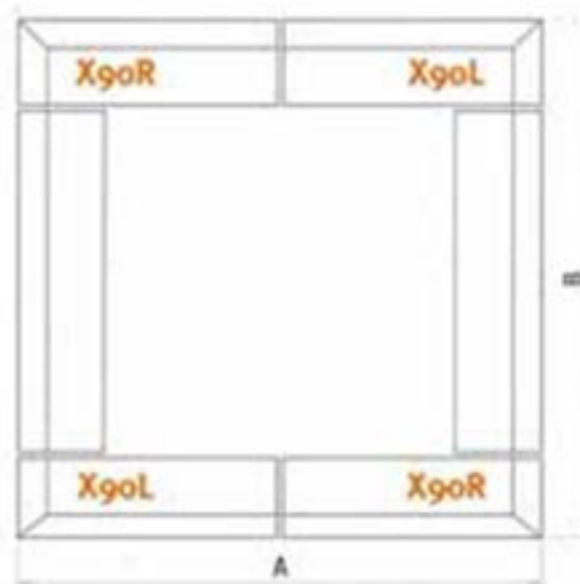

SC34

SCZ

SC29

SC30

SC32



PB300B

PL100B

PB200B

BS1

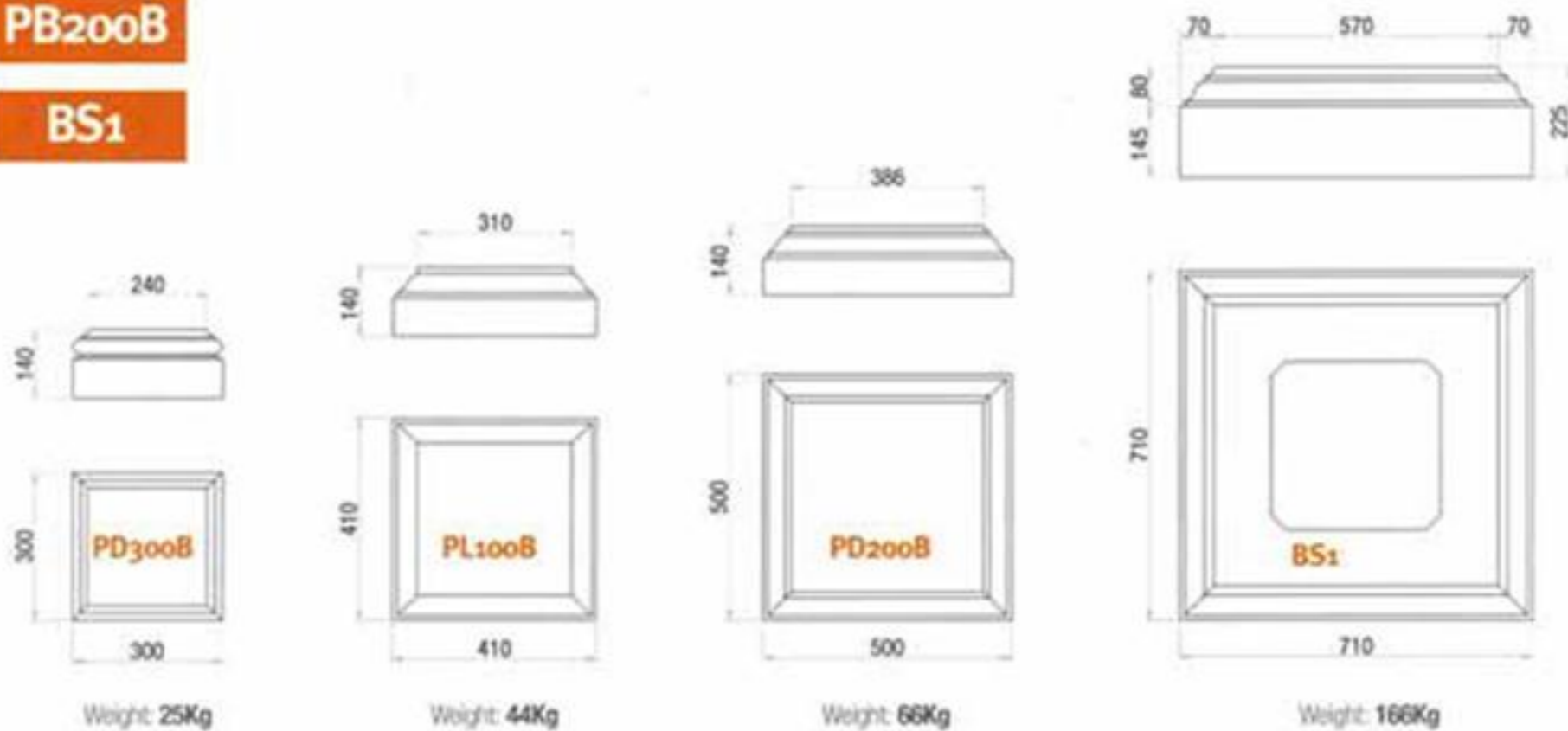

Pedestals & Plinths



PL

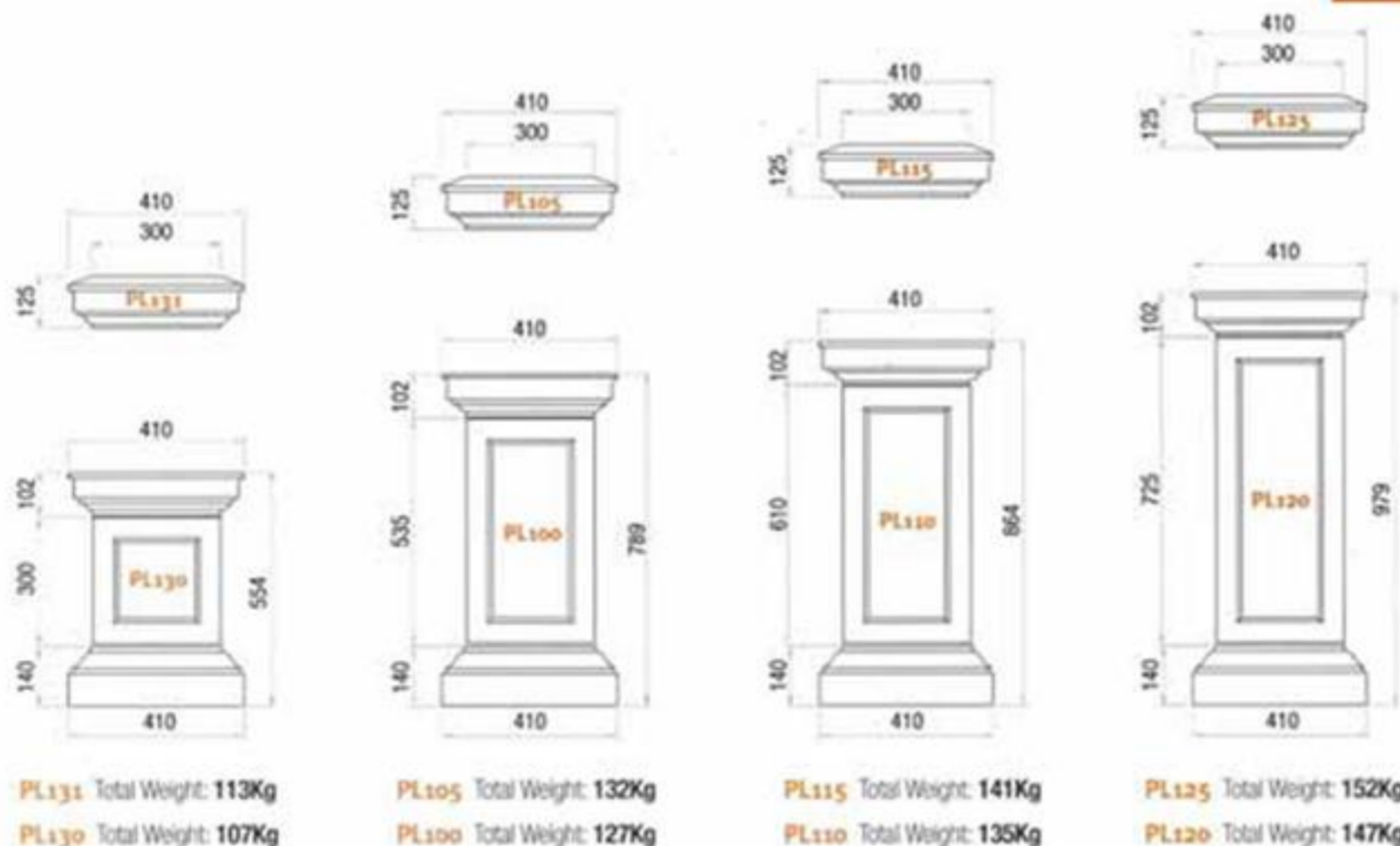

VP

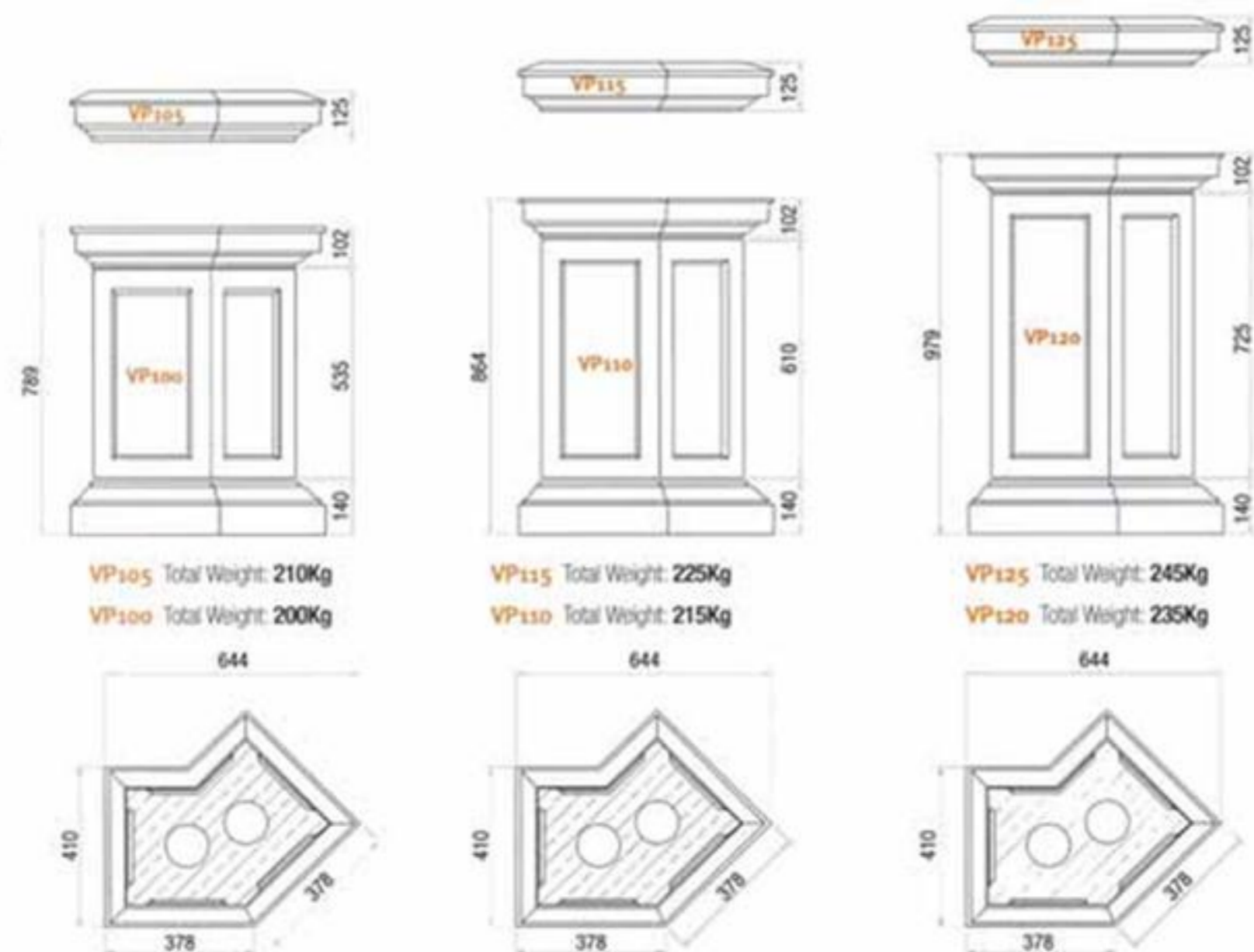



Pedestals & Plinths

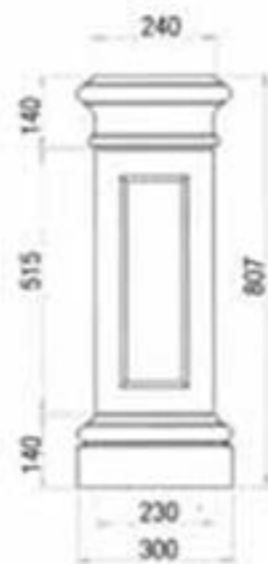

PD300
Weight: 95Kg



PD100
Weight: 45Kg

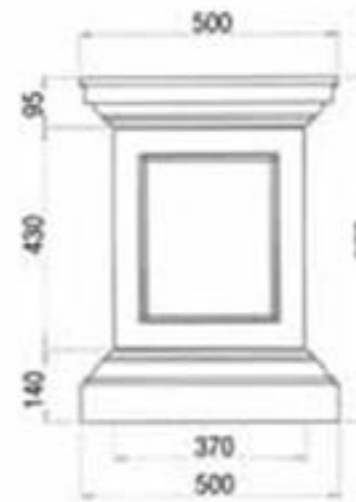

PD200
Weight: 180Kg



PD210
Weight: 225Kg

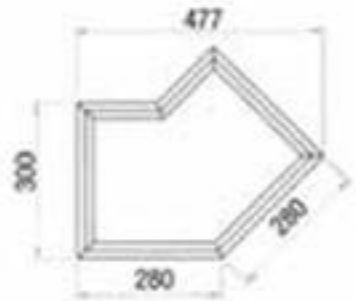

VP300
Weight: 147Kg

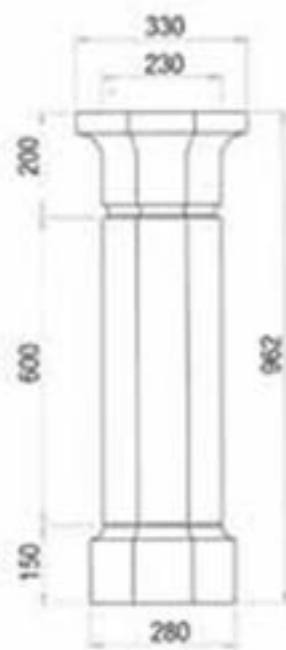

PD400
Weight: 88Kg

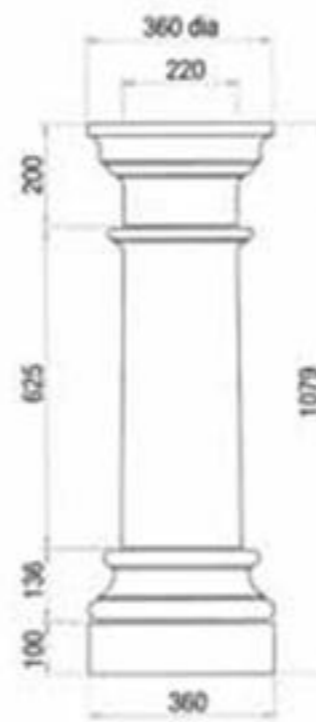

PD500
Weight: 122Kg

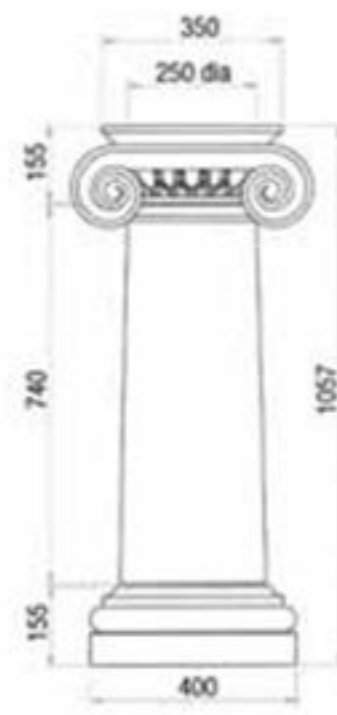

PD600
Weight: 165Kg

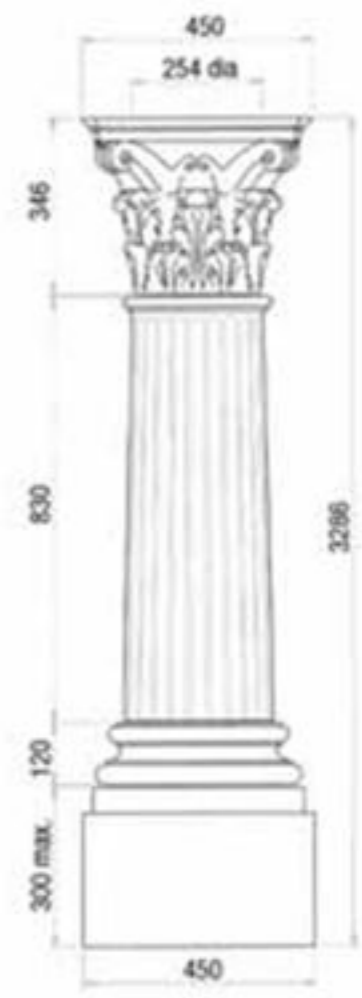

PD700
Weight: 300Kg



Finials

Please note a dowel of sufficient length should be used to secure the finial through the pier cap into the pier.

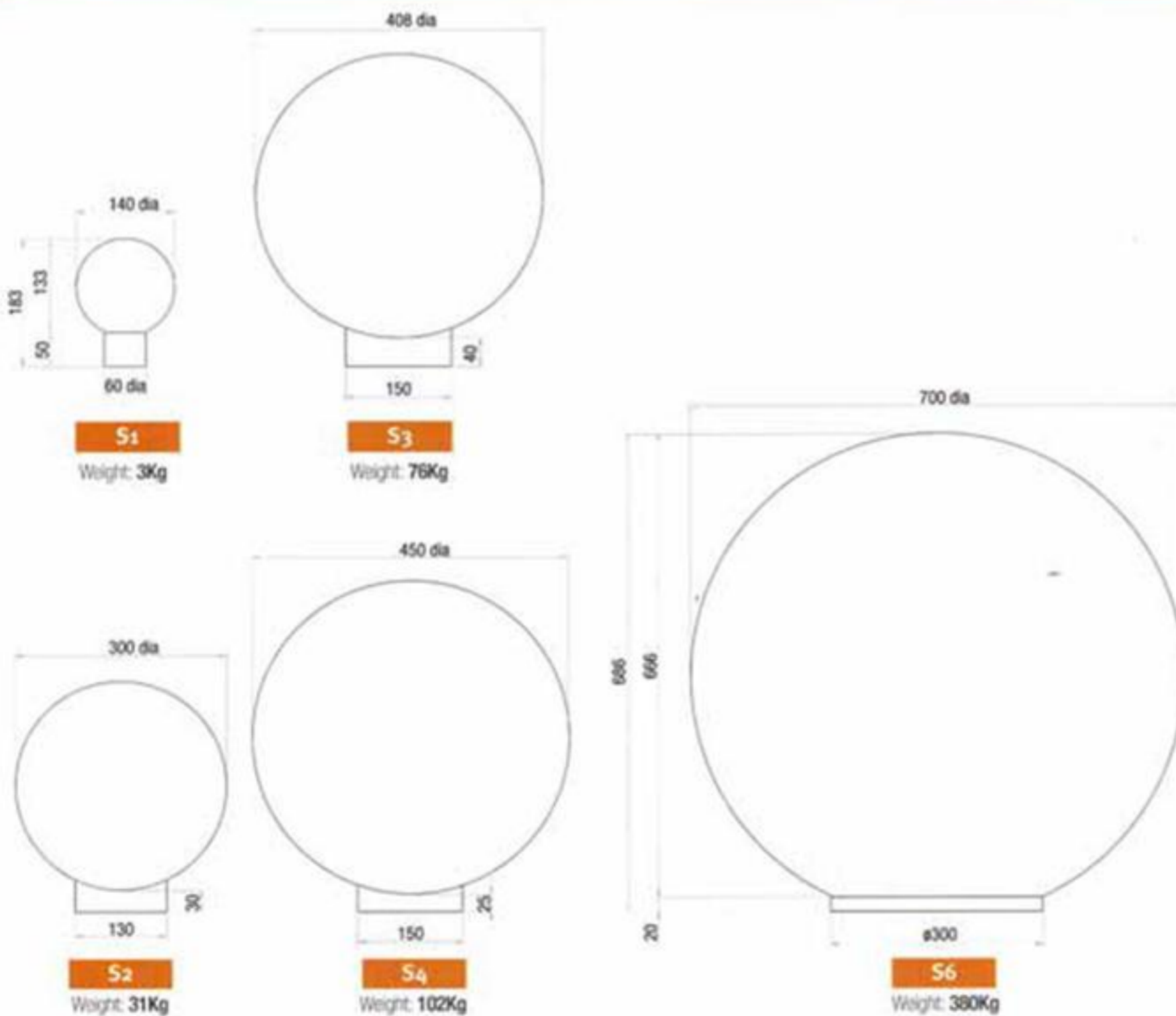
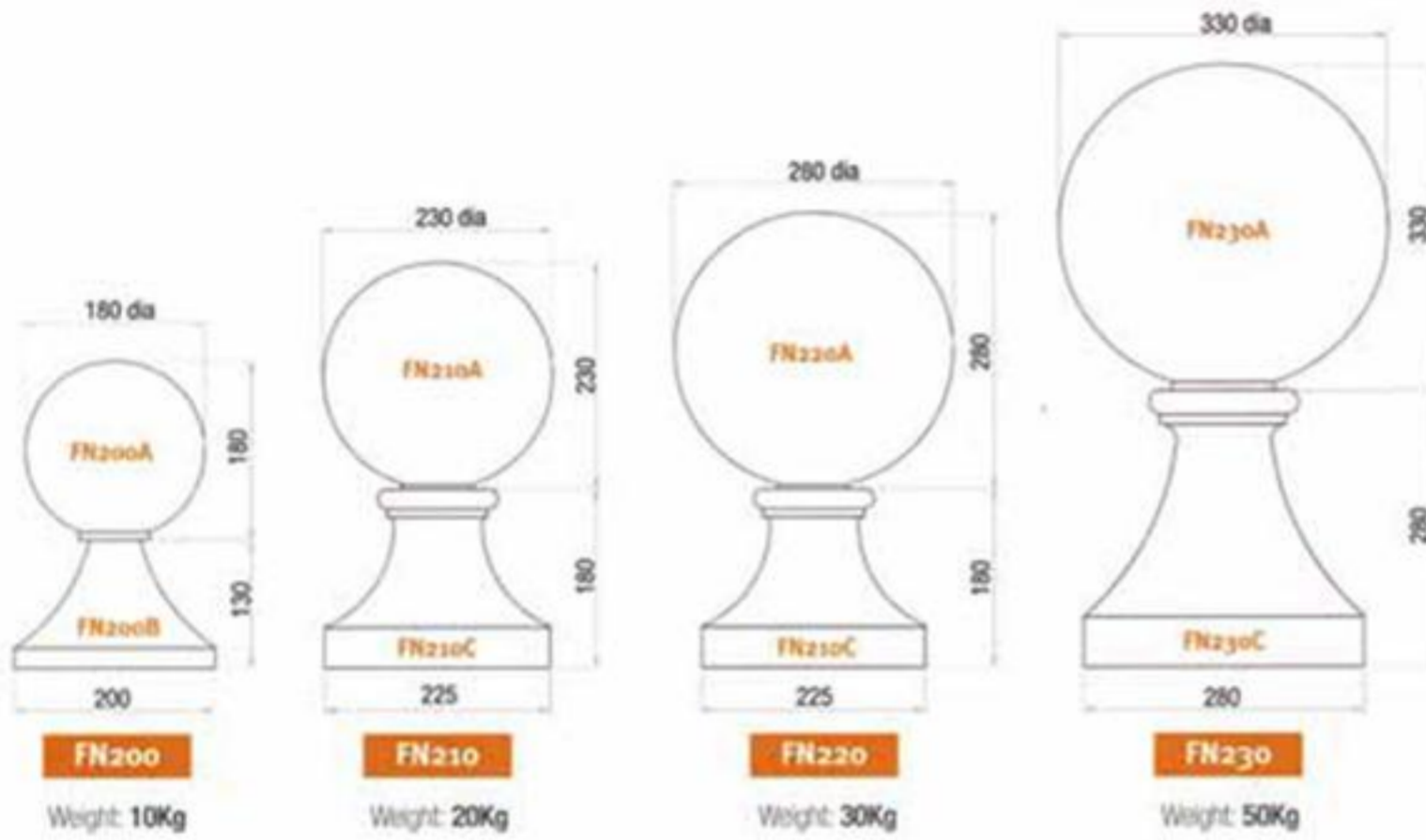



Finials

FN300

FN240A

FN230C



Weight: 118Kg



Weight: 55Kg

FN100

FN110

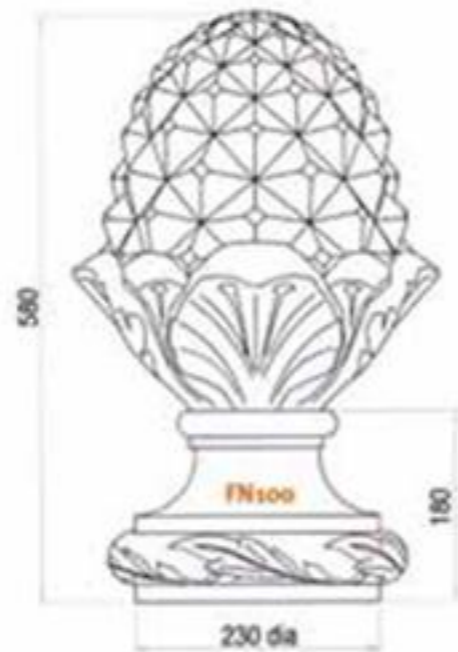

Weight: 40Kg



Weight: 40Kg

Date & Name Stones

These items are produced as blanks for carving to customers requirements. Many type font styles are available to suit the customers needs.



RS1

RS2



Weight: 48Kg



Weight: 48Kg



RS3

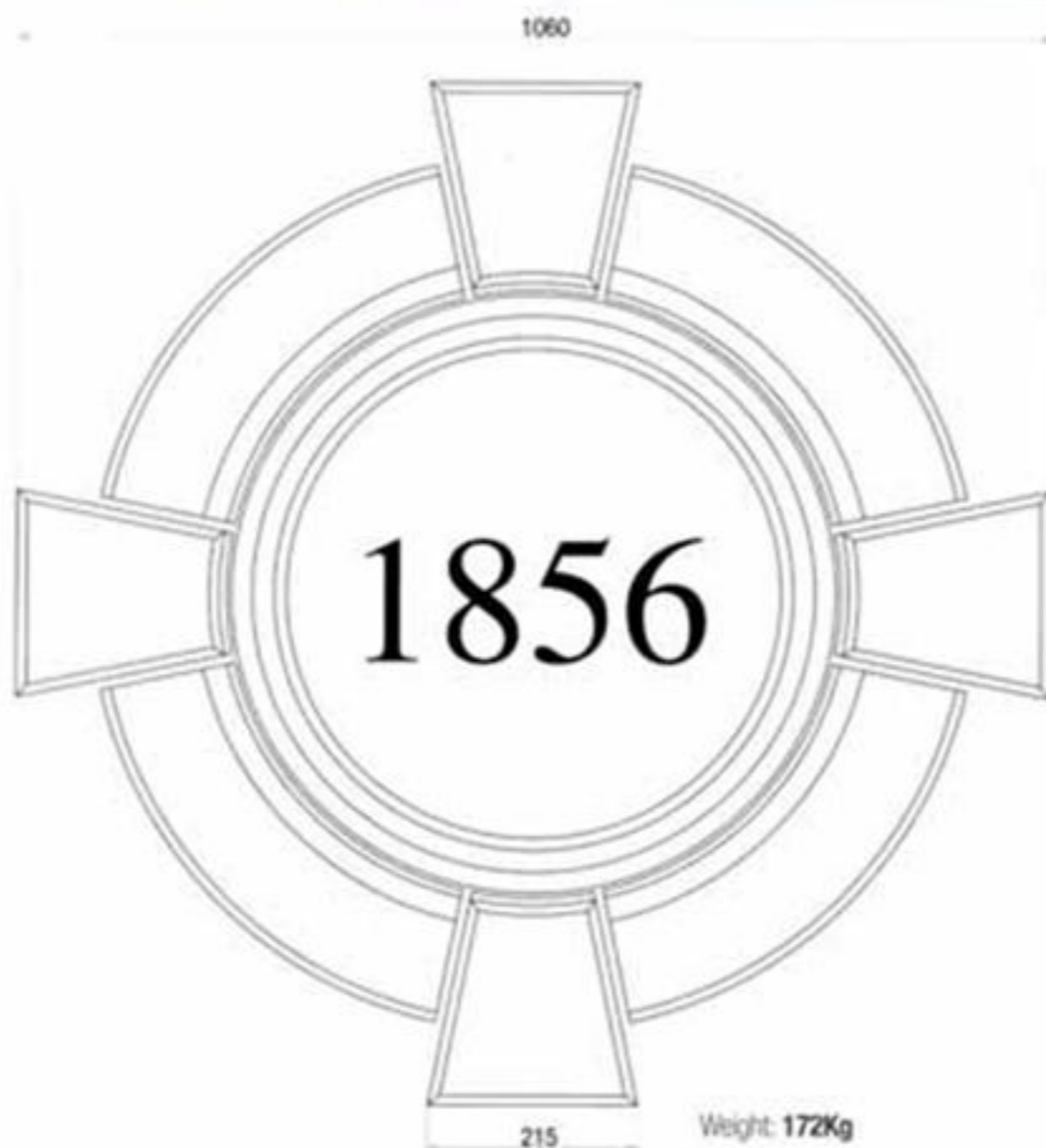

Weight: 172Kg

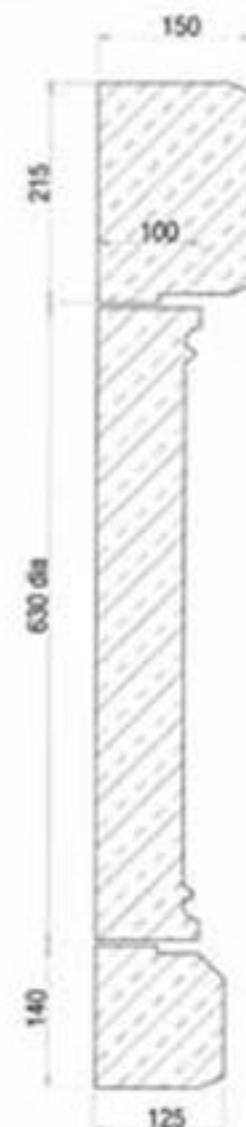

WILLISHOLME
2001

Date & Name Stones

These items are produced as blanks for carving to customers requirements.
Many type font styles are available to suit the customers needs.

DP10

Code	A	B	Weight (kg)
DP10	440	215	20
DP11	444	219	20
DP12	440	290	27
DP13	444	294	27
DP14	665	215	30
DP15	665	290	40
DP16	665	365	51
DP17	890	365	68
DP18	1115	365	85



DP20

Code	A	B	Weight (kg)
DP20	440	215	18
DP21	444	219	18
DP22	440	290	24
DP23	444	294	24
DP24	665	215	27
DP25	665	290	36
DP26	665	365	46
DP27	890	365	62
DP28	1115	365	78

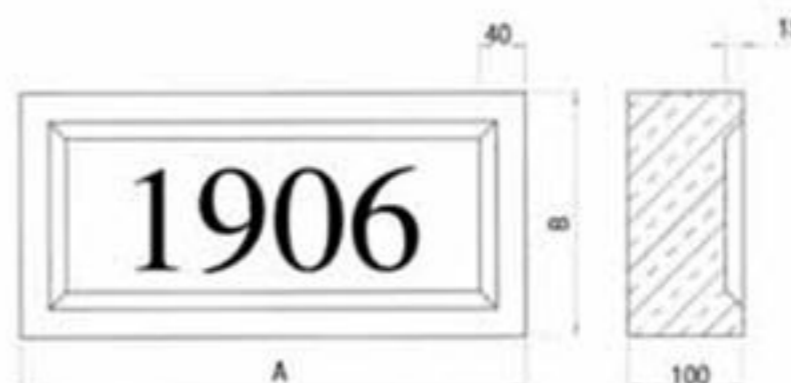

DP30

Code	A	B	Weight (kg)
DP30	440	215	24
DP31	444	219	24
DP32	440	290	32
DP33	444	294	32
DP34	665	215	36
DP35	665	290	48
DP36	665	365	61
DP37	890	365	81
DP38	1115	365	102

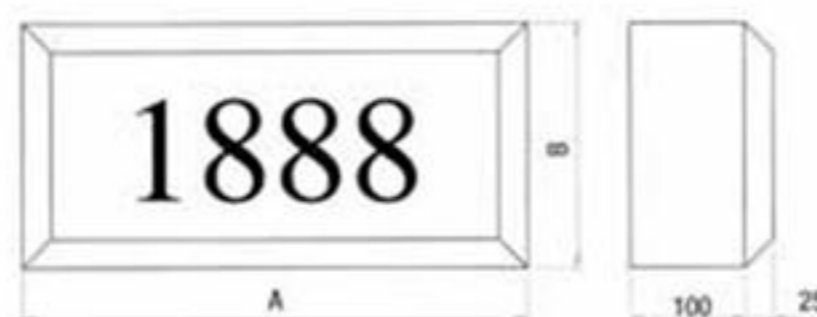

Date & Name Stones

These items are produced as blanks for carving to customers requirements. Many type font styles are available to suit the customers needs.



DP1

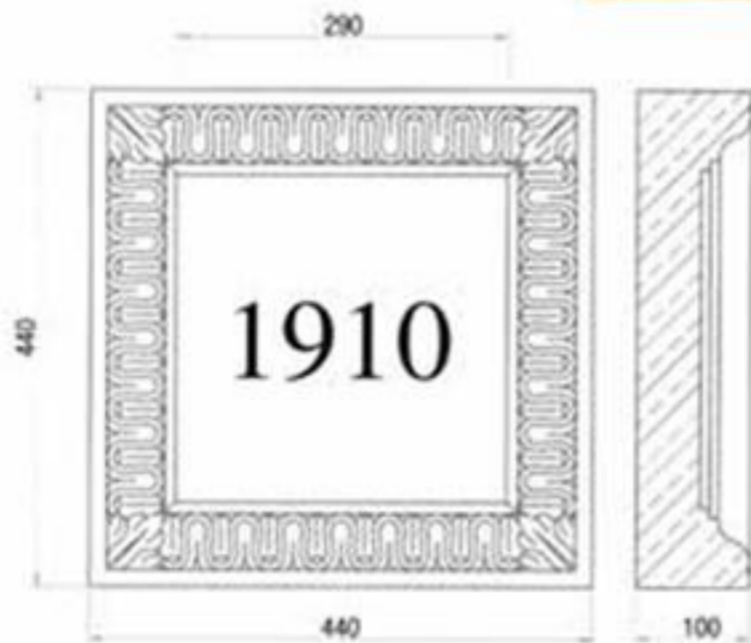

Weight: 27Kg

DP2

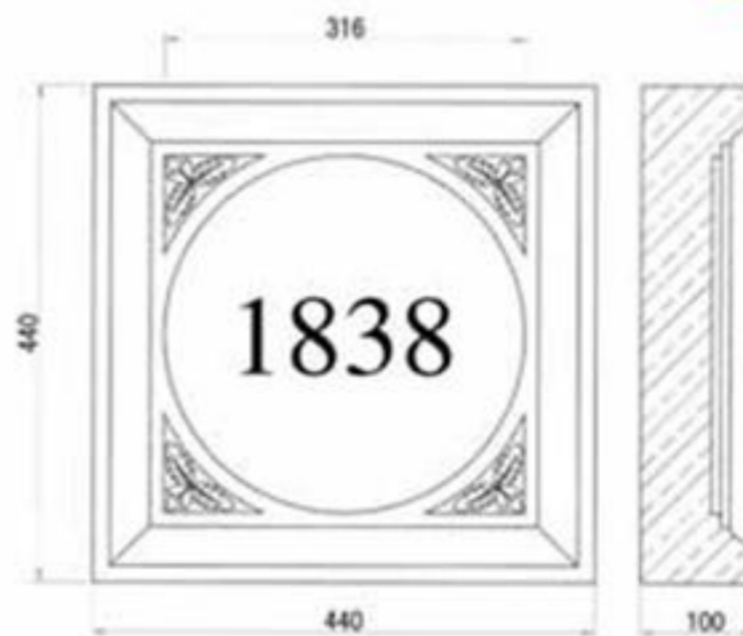

Weight: 30Kg

DP3

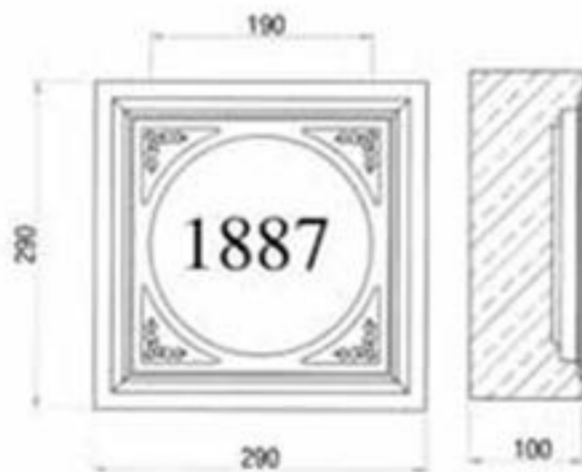

Weight: 14Kg

DP4

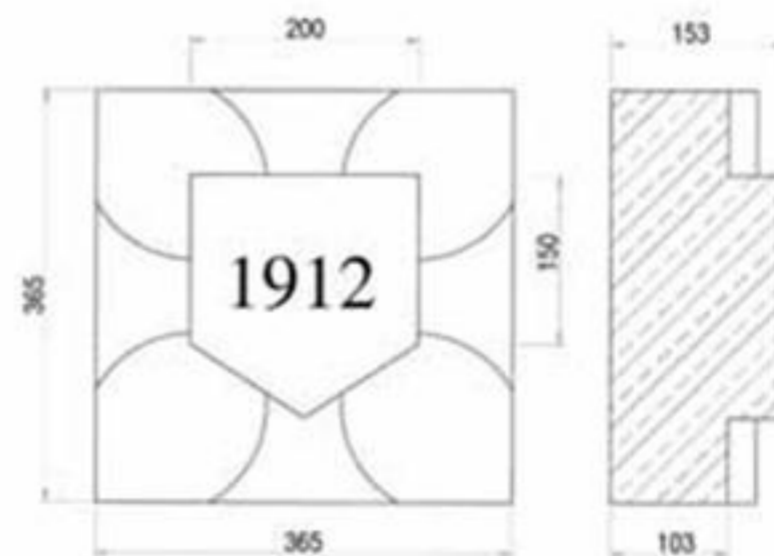

Weight: 36Kg

DP5

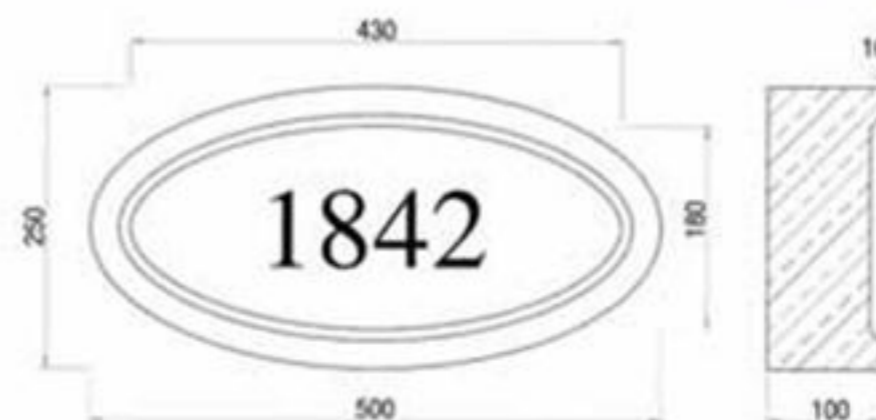

Weight: 19Kg

Date & Name Stones

These items are produced as blanks for carving to customers requirements. Many type font styles are available to suit the customers needs.



DP40 (See table below)



DP45

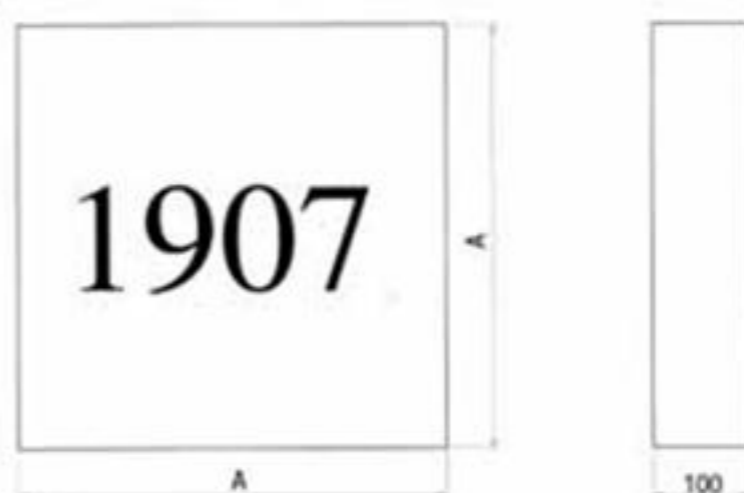

DP50 (See table below)



DP55

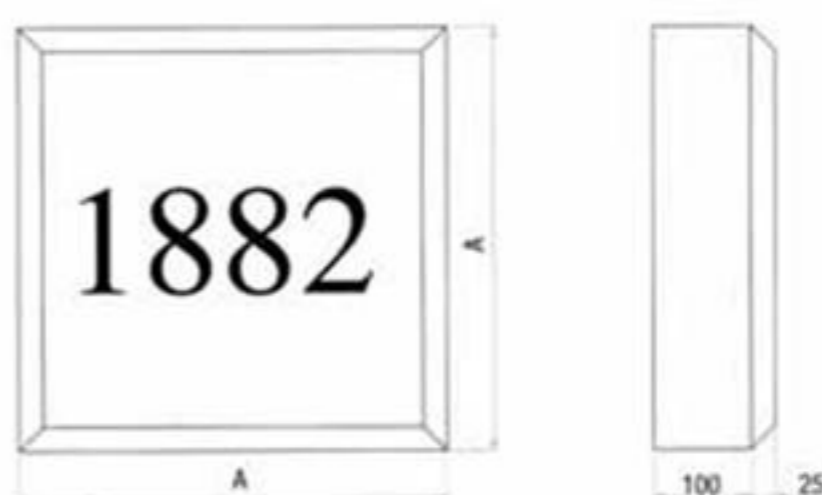

DP60 (See table below)



DP65

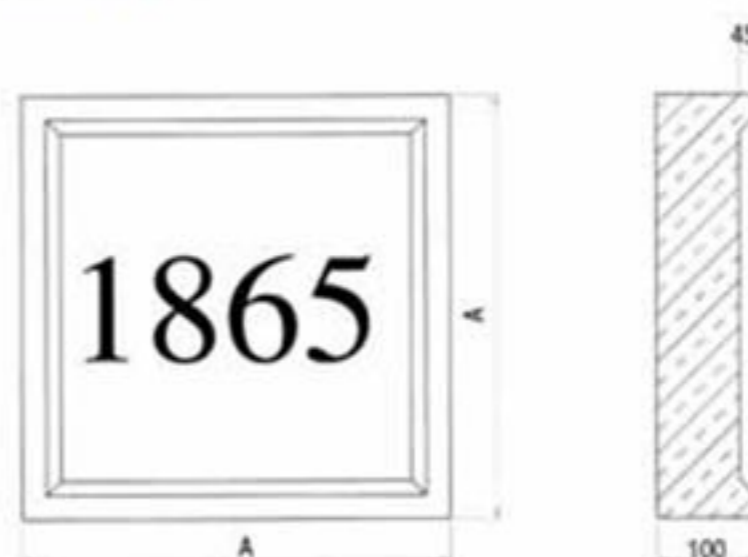

Code	A	Weight (kg)
DP40	290	18
DP41	440	41
DP42	444	41
DP43	665	93
DP44	890	166

Code	A	Weight (kg)
DP50	290	22
DP51	440	50
DP52	444	50
DP53	665	114
DP54	890	203

Code	A	Weight (kg)
DP60	290	17
DP61	440	38
DP62	444	38
DP63	665	85
DP64	890	144

Date & Name Stones



These items are produced as blanks for carving to customers requirements. Many type font styles are available to suit the customers needs.

Dimension 'A' = 3 x 'B' + 20mm

(See table below) **DP70**



(See table below) **DP80**



(See table below) **DP90**



Code	A	Weight (kg)
DP70	440	92
DP71	525	110
DP72	600	126
DP73	725	152
DP74	890	187

Code	A	Weight (kg)
DP80	290	114
DP81	440	136
DP82	444	156
DP83	665	189
DP84	890	232

Code	A	Weight (kg)
DP90	290	75
DP91	440	89
DP92	444	101
DP93	665	120
DP94	890	147

Date & Name Stones

These items are produced as blanks for carving to customers requirements. Many type font styles are available to suit the customers needs.

Dimension 'A' = 3 x 'B' + 20mm



DP100

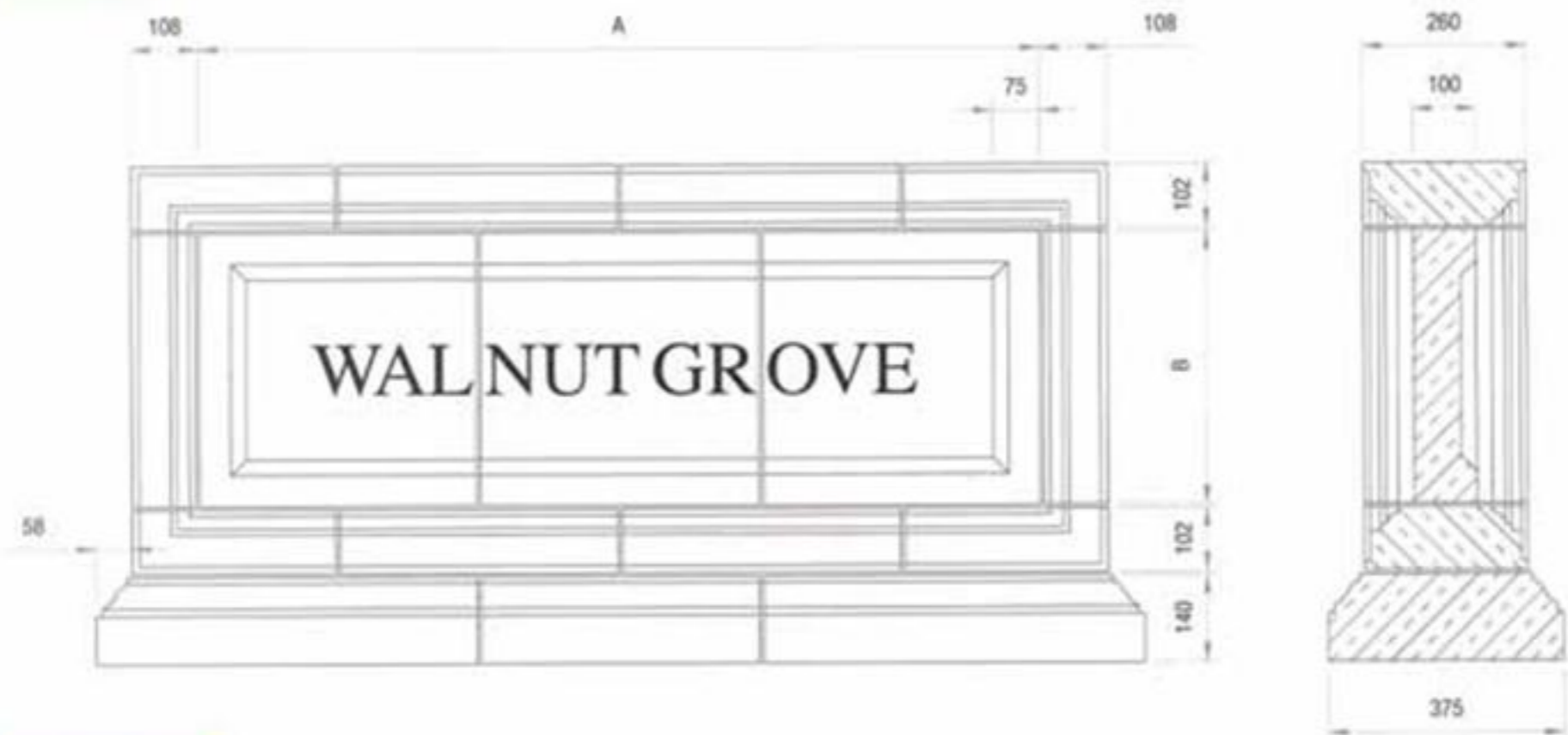

Code	B
DP100	440
DP101	525
DP102	600
DP103	725
DP104	890

DP200



Code	B
DP200	440
DP201	525
DP202	600
DP203	725
DP204	890

Fireplace Surrounds



Fire surrounds that will accommodate standard gas fires can also be supplied.

Fire surrounds are supplied complete with fixings.

The Library

CP10

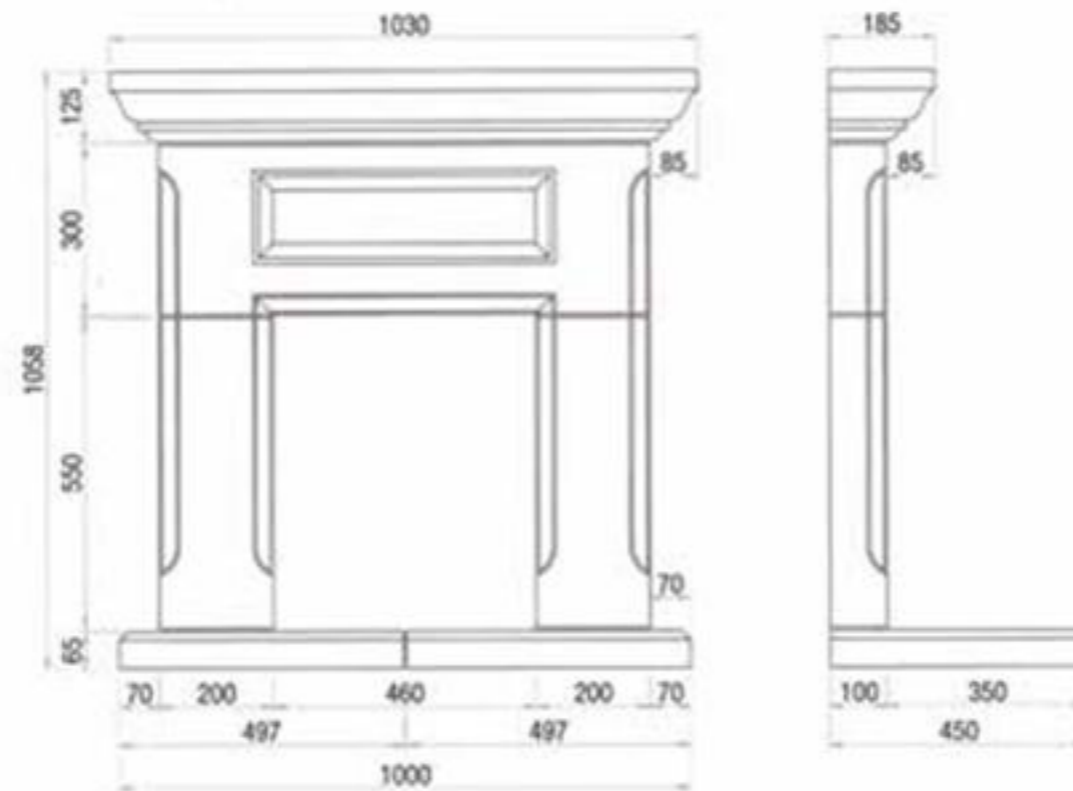

Total Weight: 195Kg

The Boningdale

CP20

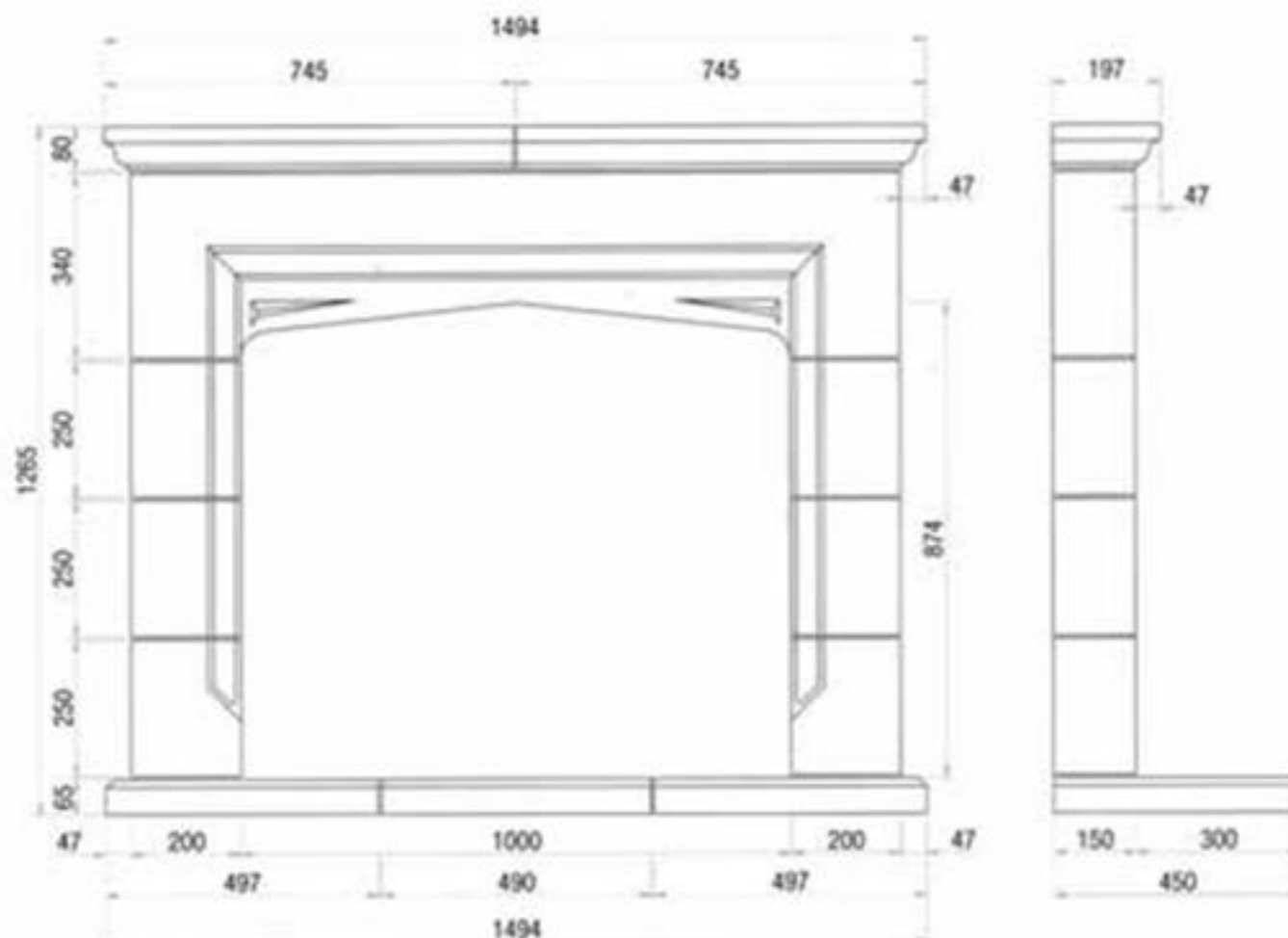

Total Weight: 355Kg



Fireplace Surrounds

Fire surrounds that will accommodate standard gas fires can also be supplied.

Fire surrounds are supplied complete with fixings.

CP40 The Rockingham

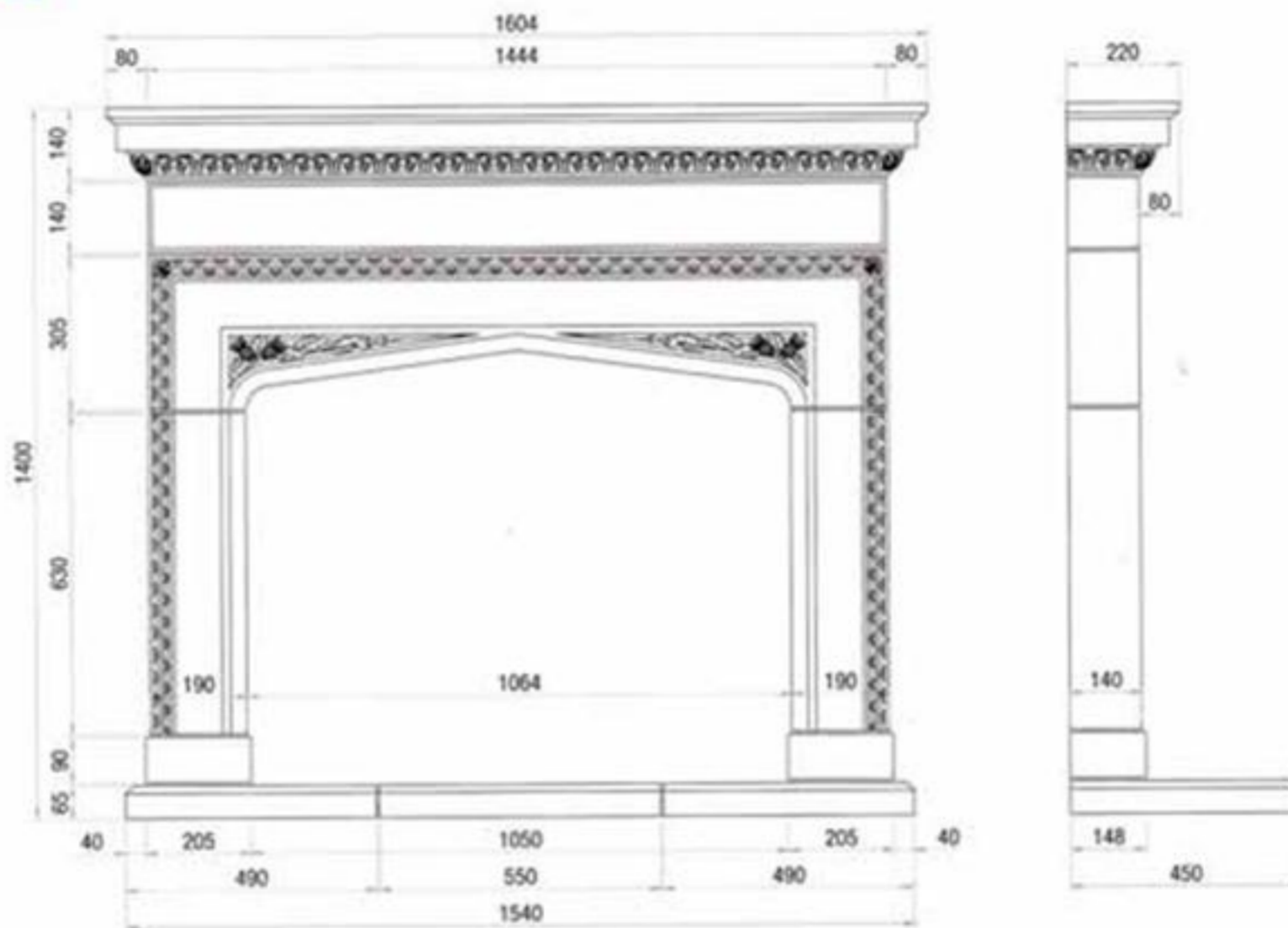

Total Weight: 390Kg

CP40 Thistle Motif

CP41 Rose Motif

CP42 Shamrock Motif



CP40



CP41



CP42