

premium products • proven solutions

Uniclass	G24: G34: G5812
CI/SfB	(52.5)

October 2010

Alumasc

# Apex Cast Iron Rainwater Systems



# Contents



	page
About Alumasc	3
Introduction to Cast Iron Rainwater Systems	4
General Description	5
Range Summary	6
Components from Stock	
■ Half Round Gutters and Fittings	8
■ Beaded Half Round Gutters and Fittings	9
■ Ogee Gutters and Fittings	10
■ Moulded Gutters and Fittings	12
■ Gutter Fixings	13
■ Round Pipes and Fittings	14
■ Square Pipes and Fittings	18
Made to Order	
■ Introduction	28
■ Gutters	29
■ Rainwater Heads and Enrichments	30
Installation	32
Specification	34

# About Alumasc

## Alumasc Exterior Building Products Ltd

Alumasc Exterior Building Products (Alumasc) is a leading supplier of premium products and systems for specification, generating an annual turnover in excess of £26 million. The Company has been a major force in the UK construction industry for over 35 years, during which time Alumasc products and systems have been used on some of Europe's most prestigious buildings.

The company is part of the Alumasc Group plc. The Group has over 800 employees, generating turnover in excess of £93 million. The aim is to focus on high quality, environmentally responsible building products within the construction arena in order to deliver first class customer service, long-term solutions and lasting relationships.

By pursuing sustainable building products, systems and manufacturing processes, Alumasc aims to offer specifiers a wide choice of design alternatives, with long-term peace of mind. Recognised brands such as Harmer, Apex, Derbigum, ZinCo, Hydrotech, Firestone and M.R., together with Alumasc's well-known architectural rainwater range have been independently certified, and in some cases have a lifespan in excess of 60 years or for the life of the building.

Alumasc brands are divided into distinct but interrelated groups:

- Rainwater
- Drainage
- Waterproofing
- Façades

## Services and Support

Alumasc leads the way in the field of construction product and system manufacture and the delivery of proven solutions. This success is founded on four key areas:

### Premium Products

A constantly evolving range of quality proven, world class products and systems, fully accredited to UK, European and North American Standards.

### Technical Support

Comprehensive data for specification and use of all products and systems is available in published form, and on the company website. This is backed up by proactive project support, led by specialist area managers and using the latest CAD and calculation technology.

### National Stockists

Alumasc rainwater and drainage products are available through a national network of stockists. This allows close control over all matters to ensure first class customer service.

### Warranties

Alumasc products come with company backed assurance as to their quality, life expectancy and suitability for purpose, ensuring long-term peace of mind for specifiers and end users.



## Quality and Sustainability

### Quality: ISO 9001: 2008

Alumasc operates a quality management system which is independently audited to ISO 9001: 2008. The ISO 9001 framework governs the management of many aspects of Alumasc support services, manufacturing and transport operations. Alumasc extends quality management to its network of approved installers for single source accountability and peace of mind.

### Environment: ISO 14001: 2004

Alumasc's manufacturing sites are audited to the ISO 14001:2004 Environmental Management Standard. Alumasc is committed to achieving improvements across all of its operating sites, not only as a good neighbour to the surroundings of manufacturing plants, but in the responsible sourcing of raw materials and monitoring of the impact on the environment as a whole.

### BREEAM Standards

The BREEAM points system promotes the use of sustainable materials and allows designers to differentiate between products with true ecological credentials and those not achieving the benchmark.

Alumasc's cast iron rainwater systems are part of the range of high scoring Alumasc solutions.



# Apex Heritage Cast Iron Rainwater Systems



## Key Benefits

- Authentic sand castings
- Range of standard sizes available along with a made to order range
- Extremely strong, durable and vandal resistant
- Life expectancy in excess of 40 years
- Silent in operation
- Dimensionally accurate and stable
- Consistent surface ready to receive final site finish
- Products also available pre-finished in satin black
- Pre-finished cast iron can cut costs by 30% and installation time by 60%
- Pre-finished cast iron is supplied wrapped for protection during transportation and site handling
- Special Hydrostrip jointing system for half round gutters
- Minimal maintenance
- Complies with BS 460: 2002 Cast Iron Rainwater Goods
- Cast iron is 100% recyclable

## Introduction

Sand cast iron has a robust timeless quality evocative of the great engineering achievements of Brunel and the Victorian age. Apex Heritage cast iron, from Alumasc, retains the best of such traditional qualities while adding the advantages of modern technology to address the needs of construction today.

Innovations such as pre-finishing and more advanced jointing methods (Alumasc's Hydrostrip system) mean that Apex Heritage cast iron represents the best of our traditional past, while being fully in tune with modern construction and performance requirements. It offers the ideal solution for new building and restoration alike.

The product range comprises traditional gutter profiles, round and square pipes, and all associated fittings and accessories. Products are available from stock or made to order. Through Apex Heritage made to order cast iron, Alumasc is able to offer virtually any profile or design - including new designs or products made to match or replace existing installations.





## General Description

Apex Heritage cast iron products are produced by the traditional sandcast method, in which the sand not only imparts the authentic cast iron texture and appearance but also allows – for example – pipe collars and ears to be cast in one piece with downpipes.

Alumasc combines traditional sand casting expertise with new methods wherever appropriate. The company has perfected the welding of cast iron so that fittings or offsets to suit a particular situation can be specially fabricated where the alternative of making a pattern and casting would not be economic.

Alumasc holds master patterns for a wide range of gutter profiles, downpipes and accessories, which can be manufactured to order.

## Finish

Apex Heritage cast iron rainwater products are supplied factory primed or pre-finished in satin black with other colours available on request.

### Pre-finished

Pre-finished products utilise a three-coat system, which has been specifically developed for cast iron, to provide a smooth and long-lasting finish. Alumasc offers the most comprehensive range of pre-finished traditional sand cast iron in the UK, including all components such as union clips, stop ends, outlets, angles, brackets, pipe bands, diminishing pieces, branches, offsets, access pipes and shoes, plus rainwater heads and sockets – a complete ready to install integrated system.

### Factory-primed

Factory-primed products are supplied with one coat of protective red oxide primer. This primer will give protection against corrosion during transportation and short-term undercover storage, and will provide a suitable surface for final painting. On-site handling and painting are the responsibility of the contractor, and particular environmental considerations should be taken into account when choosing the paint system for the final finishing.

Alumasc recommends that an additional priming coat be applied on site, followed by 1 undercoat and 2 gloss coats of an alkyd paint system. All individual elements should receive the first of the gloss coats before fixing, and finished with the final gloss coat after the installation is complete.

All exposed surfaces must be treated in this way. It is advisable to take the paint finish inside collars and within the ends of rainwater pipes to avoid the possibility of rust staining.

## On-Site Handling

Cast iron can be cut and drilled on site with metalworking tools. Site-cut ends and drilled holes exposing bare metal must be de-burred and then repainted in accordance with Alumasc's recommended site painting procedure.

Sand cast iron is inherently strong and durable, but like all high quality materials it must be handled and stored in an appropriate manner.

To avoid accidental damage to collars and spigots, gutter and pipe sections should be stored horizontally, supported clear of the ground and preferably under cover.

Alumasc pre-finished cast iron is supplied wrapped to protect against physical damage during transportation and site handling.



## Range Summary



Apex Heritage Cast Iron - traditional cast iron rainwater products that are sand cast in the traditional way for authenticity and longevity.

Typical examples of Apex Heritage gutters, pipes, rainwater heads and associated fittings are illustrated here.

For the complete Apex Heritage range of gutters, round and square pipes, and all associated fittings and fixings - see tables on pages 8-26.

Apex Heritage cast iron can also be made to order to virtually any pattern - see pages 28-30.

## Finishes



### Primed Finish

Alumasc supplies cast iron products factory-primed with one coat of protective red oxide primer. This primer will give protection against corrosion during transportation and short-term undercover storage, and will provide a suitable surface for final painting. On-site handling and painting are the responsibility of the contractor.



### Painted Finish

The renowned quality of Apex Heritage cast iron is now available in a high performance satin pre-finish black. The finish comprises a three coat system, factory-applied under controlled conditions, and has been specifically developed give a smooth and long lasting finish to the cast iron.



### Gutter Jointing

Half round gutters can be jointed using Alumasc's special Hydrostrip system, comprising pre-formed rubber seals that are quick and easy to install, and totally reliable - see page 32.

## Cast Iron Gutters

Available in four profiles in both primed and painted finishes (bespoke range also available - see Made to Order range for details).



Half Round (4 sizes)

100mm (4")  
113mm (4½")  
125mm (5")  
152mm (6")

See page 8



Beaded Half Round (2 sizes)

113mm (4½")  
125mm (5")

See page 9

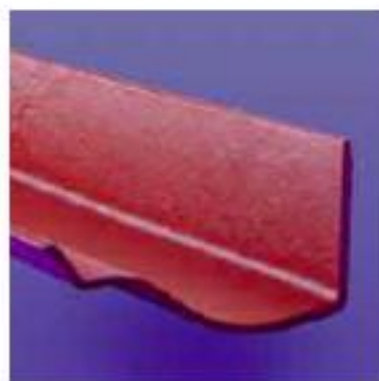

Victorian Ogee (2 sizes)

113mm (4½")  
125mm (5")

See page 10



Moulded (3 sizes)

100 x 75mm (4 x 3")  
125 x 100mm (5 x 4")  
150 x 100mm (6 x 4")

See page 12

## Cast Iron Downpipes

Available in a choice of round or square, with authentic socketed joints (bespoke range also available - see Made to Order range for details).



Circular Pipes (3 pipe sizes)

63mm (2½")\*  
76.5mm (3")\*  
102mm (4")\*

2 pipe lengths

1.83m (6ft)  
0.9m (3ft)

\* Rounded figure

See page 14

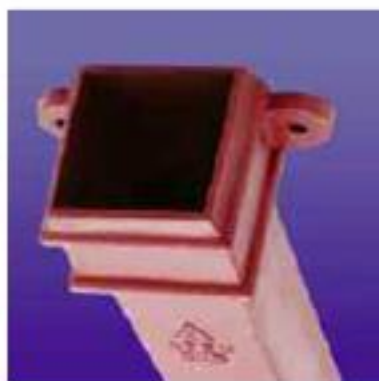

Square/Rectangular Pipes (5 pipe sizes)

75 x 75mm (3 x 3")  
100 x 75mm (4 x 3")  
100 x 100mm (4 x 4")  
125 x 100mm (5 x 4")  
150 x 100mm (6 x 4")

2 pipe lengths

1.83m (6ft)  
0.9m (3ft)

See page 18



Circular Outlet

Flat Back, Corner, Rectangular Small, Rectangular Large to fit pipe diameters:

63mm (2½")  
76.5mm (3")  
102mm (4")

See page 17



Square Outlet

Rectangular Large, Rectangular Small to fit pipes:

75 x 75mm (3 x 3")  
100 x 75mm (4 x 3")  
100 x 100mm (4 x 4")  
125 x 100mm (5 x 4")  
150 x 100mm (6 x 4")

See page 25

Bespoke rainwater heads are also available and can be made to order from our wide range of patterns.  
See page 30



## Rainwater Heads

Available from stock in a choice of two styles, ornamental (flat back and corner installation) and plain rectangular. A more extensive choice of rainwater head designs is available from our Made to Order range.

# Half Round Gutters and Fittings

Apex Heritage Half Round socketed cast iron gutters are available in 4 sizes. A traditional profile with the unmistakable character and appearance of sand cast iron. There is a range of fittings and fixings as illustrated.

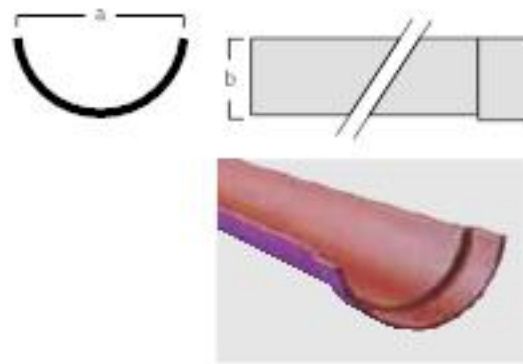

## Gutter Length

Code Ref	HG-40/6FT	HG-45/6FT	HG-50/6FT	HG-60/6FT
Gutter Lengths	1830	1830	1830	1830
a Metric	102	114	127	150
a Imperial	4"	4 1/2"	5"	6"
b	51	57	63	75
Weight (kg)	8.0	10.5	11.5	13.5

## Union Clip

Code Ref	HG-40/UC	HG-45/UC	HG-50/UC	HG-60/UC
Gutter Width	102	114	127	150
a	98	98	98	95
b	44	44	44	44

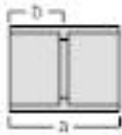

## Stop End - Left/Right Hand

Code Ref	Internal				External			
	HG-40/SE/I	HG-45/SE/I	HG-50/SE/I	HG-60/SE/I	HG-40/SE/E	HG-45/SE/E	HG-50/SE/E	HG-60/SE/E
Gutter Width	102	114	127	150	102	114	127	150
a	44	44	44	44	51	51	51	51



## Running Outlet with Double Socket

Code Ref	Pipe 63 Dia			Pipe 76.5 Dia				Pipe 102 Dia	
	HG-40/RO/25	HG-45/RO/25	HG-50/RO/25	HG-40/RO/30	HG-45/RO/30	HG-50/RO/30	HG-60/RO/30	HG-50/RO/40	HG-60/RO/40
Gutter Width	102	114	127	102	114	127	150	127	150
a	156	156	156	156	156	156	156	156	156
b	121	121	121	121	121	121	121	121	121
c	44	44	44	44	44	44	44	44	44

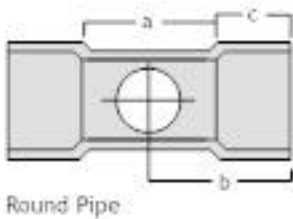

## Internal/External Angle with Socket

Code Ref	90 Degree				120 Degree				135 Degree			
	HG-40/A/90	HG-45/A/90	HG-50/A/90	HG-60/A/90	HG-40/A/120	HG-45/A/120	HG-50/A/120	HG-60/A/120	HG-40/A/135	HG-45/A/135	HG-50/A/135	HG-60/A/135
Gutter Width	102	114	127	150	102	114	127	150	102	114	127	150
a	190	200	209	235	124	124	136	140	124	124	137	128
b	79	79	79	79	79	76	79	75	79	76	79	75
c	44	44	44	44	44	44	44	44	44	44	44	44

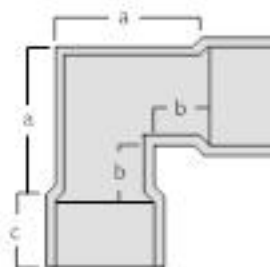

90 Degree

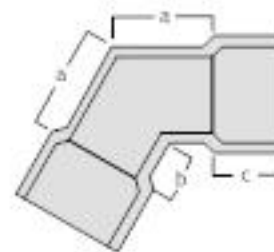

120 Degree

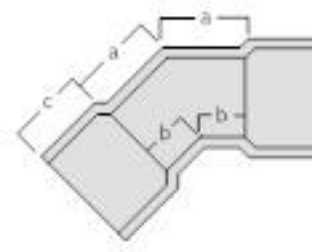

135 Degree

### Note

Products are available with either a red oxide primed coating, or pre-finished in satin back. Code references in the tables refer to primed products. For Pre-Finished products add the suffix /PA to the order code reference.



# Beaded Half Round Gutters and Fittings

Apex Heritage Beaded Half Round socketed cast iron gutters, in 2 sizes, incorporate a pronounced feature bead on both lips. This adds character and definition to the gutter edge in a true sand cast product. Fittings and fixings are also available as illustrated.

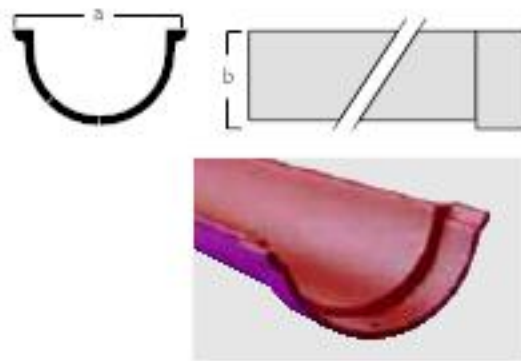

## Gutter Length

Code Ref	BG45/6FT	BG50/6FT
Gutter Lengths	1830	1830
a Metric	114	127
a Imperial	4 1/2"	5"
b	57	63
Weight (kg)	11.0	12.5

## Union Clip

Code Ref	BG45/UC	BG50/UC
Gutter Width	114	127
a	78	78
b	44	44

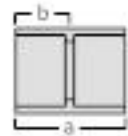

## Stop End - Left/Right Hand

Code Ref	Internal		External	
	BG45/SE/I	BG50/SE/I	BG45/SE/E	BG50/SE/E
Gutter Width	114	127	114	127
a	44	44	51	51



## Running Outlet with Double Socket

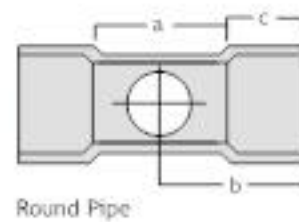

Round Pipe

Code Ref	Pipe 63 Dia		Pipe 76.5 Dia		Pipe 102 Dia
	BG45/RO/25	BG50/RO/25	BG45/RO/30	BG50/RO/30	BG50/RO/40
Gutter Width	114	127	114	127	127
a	156	156	156	156	156
b	121	121	121	121	121
c	44	44	44	44	44

## Internal/External Angle with Socket

Code Ref	90 Degree		120 Degree		135 Degree	
	BG45/A/90	BG50/A/90	BG45/A/120	BG50/A/120	BG45/A/135	BG50/A/135
Gutter Width	114	127	114	127	114	127
a	206	216	130	140	130	140
b	70	70	76	79	76	79
c	44	44	44	44	44	44

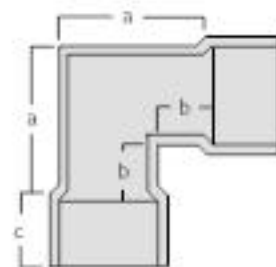

90 Degree

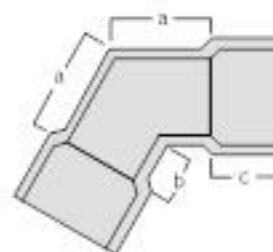

120 Degree

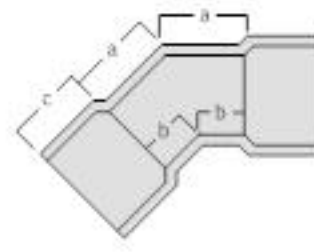

135 Degree

### Note

Products are available with either a red oxide primed coating, or pre-finished in satin back. Code references in the tables refer to primed products. For Pre-Finished products add the suffix /PA to the order code reference.

# Ogee Gutters and Fittings

Apex Heritage Ogee cast iron socketed gutters are available in 2 sizes. An elegant Victorian ogee profile combined with the robust visual quality of sand cast iron. There is a range of fittings and fixings as illustrated.

**Note**

On direct fix installations, it is advisable to tack a small spacer batten on the fascia board to ensure the base of the gutter is level.

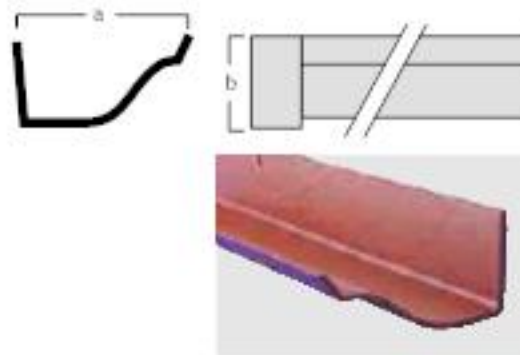

## Gutter Length

Code Ref	OG45/6FT	OG50/6FT
Gutter Lengths	1830	1830
a Metric	114	127
a Imperial	4 7/8"	5"
b	54	63
Weight (kg)	11.5	12.5

## Union Clip

Code Ref	OG45/UC	OG50/UC
Gutter Width	114	127
a	78	78
b	44	44

## Stop End - Left Hand

Code Ref	Internal		External	
	OG45/SE/LI	OG50/SE/LI	OG45/SE/LE	OG50/SE/LE
Gutter Width	114	127	114	127
a	44	44	54	54

## Stop End - Right Hand

Code Ref	External	
	OG45/SE/RE	OG50/SE/RE
Gutter Width	114	127
a	54	54

## Running Outlet with Single Socket

Code Ref	Pipe 63 Dia		Pipe 76.5 Dia		Pipe 102 Dia
	OG45/RO/25	OG50/RO/25	OG45/RO/30	OG50/RO/30	OG50/RO/40
Gutter Width	114	127	114	127	127
a	200	200	200	200	200
b	121	121	121	121	121
c	44	44	44	44	44

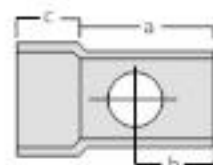

Round Pipe

**Note**

Products are available with either a red oxide primed coating, or pre-finished in satin back. Code references in the tables refer to primed products. For Pre-Finished products add the suffix /PA to the order code reference.

### External Angle with Socket

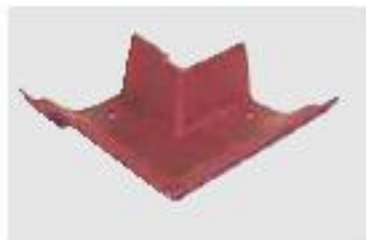

Code Ref	90 Degree		120 Degree		135 Degree	
	OG45/EA/90	OG50/EA/90	OG45/EA/120	OG50/EA/120	OG45/EA/135	OG50/EA/135
Gutter Width	114	127	114	127	114	127
a	28	28	28	28	28	28
b	76	76	76	76	76	76
c	44	44	44	44	44	44

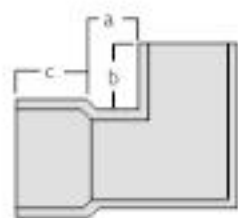

90 Degree

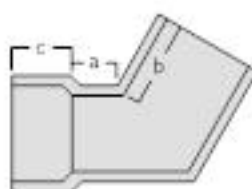

120 Degree

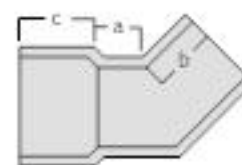

135 Degree

### Internal Angle with Socket



Code Ref	90 Degree		120 Degree		135 Degree	
	OG45/IA/90	OG50/IA/90	OG45/IA/120	OG50/IA/120	OG45/IA/135	OG50/IA/135
Gutter Width	114	127	114	127	114	127
a	156	159	98	105	86	86
b	206	216	149	159	130	130
c	44	44	44	44	44	44

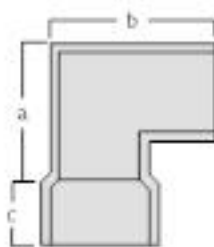

90 Degree

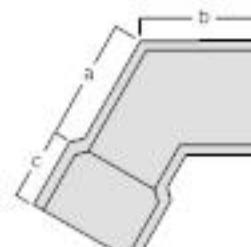

120 Degree

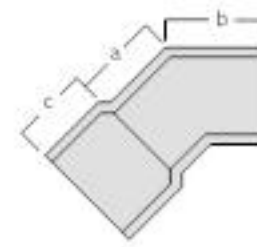

135 Degree

#### Note

Products are available with either a red oxide primed coating, or pre-finished in satin back. Code references in the tables refer to primed products. For Pre-Finished products add the suffix /PA to the order code reference.

# Moulded Gutters and Fittings

Available in 3 sizes, Apex Heritage Moulded socketed cast iron gutters have a sharply featured decorative profile. A range of fittings and fixings as illustrated completes the system.

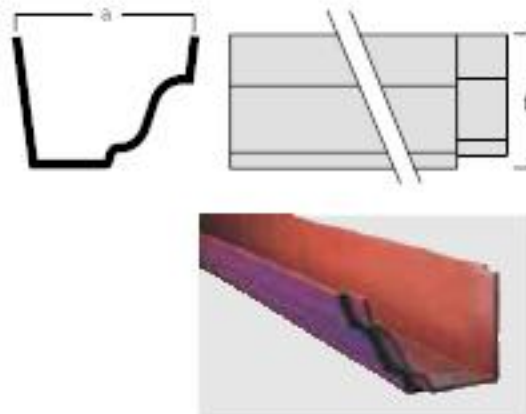

## Gutter Length

Code Ref	MG43/6FT	MG54/6FT	MG64/6FT
Gutter Lengths	1830	1830	1830
a Metric	102	127	152
a Imperial	4"	5"	6"
b	76	102	102
Weight (kg)	11.0	18.0	19.0

## Union Clip

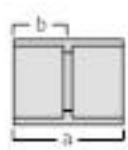

Code Ref	MG43/UC	MG54/UC	MG64/UC
Gutter Width	102	127	152
a	78	78	78
b	44	44	44

### Note

Products are available with either a red oxide primed coating, or pre-finished in satin back. Code references in the tables refer to primed products. For Pre-Finished products add the suffix /PA to the order code reference.

## Stop End - Left Hand



Code Ref	MG43/SE/LI	MG54/SE/LI	MG64/SE/LI
Gutter Width	102	127	152
a	51	51	51

## Stop End - Right Hand



Code Ref	MG43/SE/RI	MG54/SE/RI	MG64/SE/RI	MG43/SE/RE	MG54/SE/RE	MG64/SE/RE
Gutter Width	102	127	152	102	127	152
a	51	51	51	54	54	54

## Running Outlet with Single Spigot

Code Ref	Pipe 63 Dia		Pipe 76.5 Dia			Pipe 102 Dia		Pipe 75 x 75			Pipe 102 x 75			Pipe 102 x 102	Pipe 125 x 102
	MG43/RO/25	MG54/RO/25	MG43/RO/30	MG54/RO/30	MG64/RO/30	MG54/RO/40	MG64/RO/40	MG43/RO/33	MG54/RO/33	MG64/RO/33	MG43/RO/43	MG54/RO/43	MG64/RO/43	MG64/RO/44	MG64/RO/54
Gutter Width	102	127	102	127	152	127	152	102	127	152	102	127	152	152	152
a	251	251	251	251	251	251	251	251	251	251	251	251	251	251	251
b	124	124	124	124	124	124	124	124	124	124	124	124	124	124	124
f	50	50	50	50	50	50	50	50	50	50	50	50	50	50	50

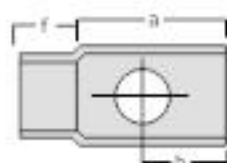

Round Pipe

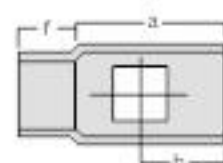

Square Pipe

### External Angle with Spigot



Code Ref	90 Degree			120 Degree			135 Degree		
	MG43/EA/90	MG54/EA/90	MG64/EA/90	MG43/EA/120	MG54/EA/120	MG64/EA/120	MG43/EA/135	MG54/EA/135	MG64/EA/135
Gutter Width	102	127	152	102	127	152	102	127	152
a	28	28	25	35	35	35	28	35	41
b	79	79	70	79	79	79	79	79	89
f	50	50	50	50	50	50	50	50	50

**Note**

Products are available with either a red oxide primed coating, or pre-finished in satin black. Code references in the tables refer to primed products. For Pre-Finished products add the suffix /PA to the order code reference.

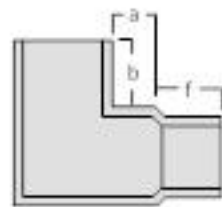

90 Degree

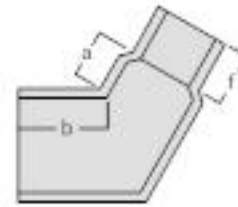

120 Degree

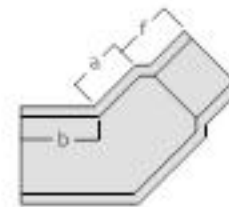

135 Degree

### Internal Angle with Spigot



Code Ref	90 Degree			120 Degree			135 Degree		
	MG43/IA/90	MG54/IA/90	MG64/IA/90	MG43/IA/120	MG54/IA/120	MG64/IA/120	MG43/IA/135	MG54/IA/135	MG64/IA/135
Gutter Width	102	127	152	102	127	152	102	127	152
a	137	168	181	60	111	124	73	89	98
b	187	216	229	111	156	168	124	137	140
f	50	50	50	50	50	50	50	50	50

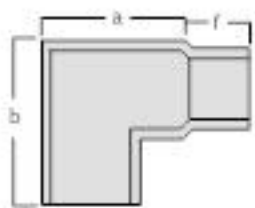

90 Degree

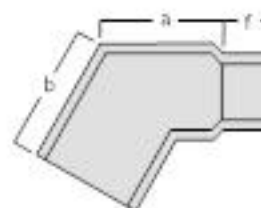

120 Degree

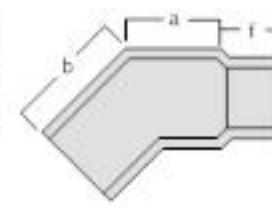

135 Degree

### Gutter Fixings

**Fascia brackets**



FB/CI  
Half Round



FB/CI  
Moulded



FB/GS  
Victorian Ogee



FB/GS  
Half Round

**Riveted fascia brackets**



RFB/GS

**L-shaped brackets**



FB/L

**Note**

Bracketry is available for all gutter sizes. Order codes should be prefixed by one of the following gutter types/sizes:  
 Half Round: HG40, HG45, HG50, HG60  
 Beaded Half Round: BG45, BG50  
 Victorian Ogee: OG45, OG50  
 Moulded: MG43, MG54, MG64  
 For example, HG40/FB/CI – See page 8 for the relevant gutter table.  
 Contact Alumasc for further information.

**Rise and fall brackets**

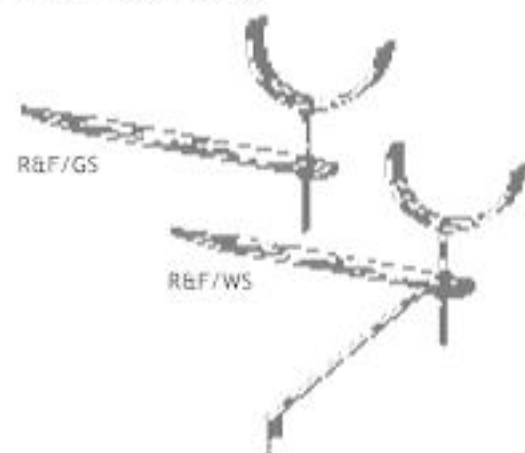

R&F/GS

R&F/WS

**Repair brackets**



REP/GS  
Half Round



REP/GS  
Moulded

**Drive in brackets**



DI/GS

RB/5F

**Top rafter brackets**



RB/TF

# Round Pipes

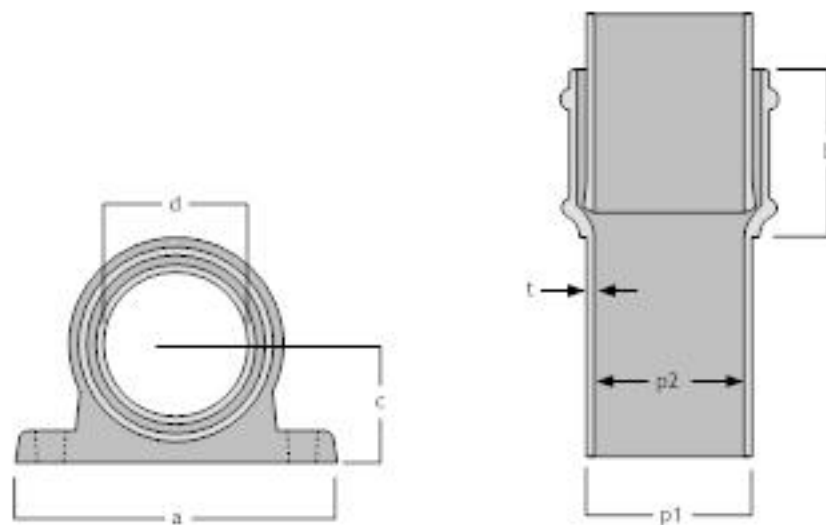

Sockets (Nominal)	63	75	100
a Width of flange	146	162	191
b Depth of socket	63.5	63.5	63.5
c Distance of centre to wall	48	54	67
d Internal ø	73	90	111

Pipes (Nominal)	63	75	100
p1 External ø	63.5	82.5	108
p2 Internal ø	57	70	95
t Thickness	3	3	3

### Notes

- 1 If bends with ears are required, add one of the following suffixes to the Ordering Reference according to its intended use:  
 \* front bend /FE  
 \* back bend /BE  
 \* lefthand bend /LE  
 \* righthand bend /RE.
- 2 If plinth offsets with ears are required, add suffix PE to the Ordering Reference.
- 3 Swan-necks can also be used as side offsets. If side offsets with ears are required, add one of the following suffixes to the Ordering Reference according to its intended use:  
 \* lefthand side offset /LE  
 \* righthand side offset /RE.
- 4 Shoes can also be used as side shoes. If side shoes with ears are required, add one of the following suffixes to the Ordering Reference according to its intended use:  
 \* lefthand side shoe /LE  
 \* righthand side shoe /RE.
- 5 If shoes with ears are required, add suffix E to the Ordering Reference.
- 6 If ears are required on single branches or diminishing pieces, please contact Alumasc Technical Services department for further details.
- 7 Should projections other than those shown be required for plinth offsets or swan-necks, please contact Alumasc Technical Services for further details.
- 8 Products are available with either a red oxide primed coating, or pre-finished in satin black. Code references in the tables refer to primed products. For Pre-Finished products add the suffix /PA to the order code reference.



# Round Pipes and Fittings

A range of traditional cast iron socketed round rainwater pipes in a choice of 3 pipe diameters and 2 pipe lengths. There is a comprehensive range of cast iron fittings, and traditional holderbat and earbelt fixings. Cast iron rainwater heads are also available to suit.



## Pipes

Code Ref	Pipe Length 0.914m			Pipe Length 1.830m		
	P25/3FT	P30/3FT	P40/3FT	P25/6FT	P30/6FT	P40/6FT
Pipe Diameter mm	63	75	100	63	75	100
Pipe Diameter inches	2 1/2"	3"	4"	2 1/2"	3"	4"

Note: Pipes are normally supplied eared. Where ears are not required add suffix /NE.

## Bends

Code Ref	92.5 Degree			112.5 Degree			135 Degree		
	P25/B/92	P30/B/92	P40/B/92	P25/B/112	P30/B/112	P40/B/112	P25/B/135	P30/B/135	P40/B/135
Pipe Diameter mm	63	75	100	63	75	100	63	75	100
Pipe Diameter inches	2 1/2"	3"	4"	2 1/2"	3"	4"	2 1/2"	3"	4"
a	63	63	63	63	63	63	63	63	63
b	76	83	95	57	60	70	44	48	51
c	140	146	159	121	124	133	108	111	114

### Notes

If bends with ears are required, add one of the following suffixes to the product:

Front Bend /FE      Back Bend /BE  
Left Hand Bend /LE      Right Hand Bend /RE.

If ears are required on single branches contact Alumasc Technical Services.

Products are available with either a red oxide primed coating, or pre-finished in satin back. Code references in the tables refer to primed products. For Pre-Finished products add the suffix /PA to the order code reference.



92.5 Degree

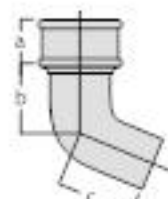

112.5 Degree

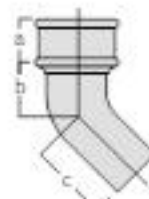

135 Degree

## Branches

Code Ref	92.5 Degree			112.5 Degree			135 Degree		
	P25/BR/92	P30/BR/92	P40/BR/92	P25/BR/112	P30/BR/112	P40/BR/112	P25/BR/135	P30/BR/135	P40/BR/135
Pipe Diameter mm	63	75	100	63	75	100	63	75	100
Pipe Diameter inches	2 1/2"	3"	4"	2 1/2"	3"	4"	2 1/2"	3"	4"
a	63	63	63	63	63	63	63	63	63
b	210	229	267	210	229	267	210	229	267
c	79	79	98	79	89	108	108	124	152

Refer to notes on facing page for Code Suffixes to be added where ears are required.

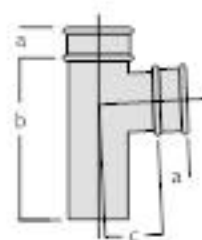

92.5 Degree

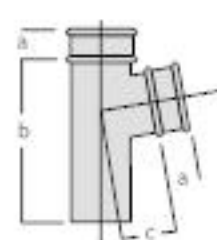

112.5 Degree

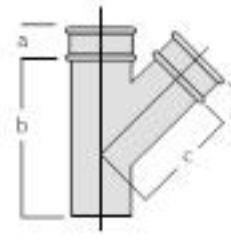

135 Degree

# Round Pipes and Fittings

## 63mm Diameter Side Offsets, Plinth Offsets and Swan Necks

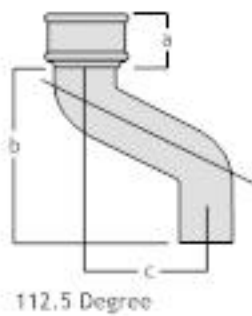

Code Ref	P25/OF/03	P25/OF/04	P25/OF/06	P25/OF/09	P25/OF/12	P25/OF/15	P25/OF/18
a	63	63	63	63	63	63	63
b	190	210	225	257	289	321	352
c	76	114	152	229	306	381	457

## 75mm Diameter Side Offsets, Plinth Offsets and Swan Necks

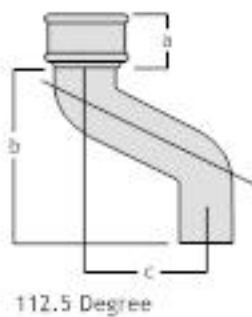

Code Ref	P30/OF/03	P30/OF/04	P30/OF/06	P30/OF/09	P30/OF/12	P30/OF/15	P30/OF/18
a	63	63	63	63	63	63	63
b	200	216	232	264	295	327	359
c	76	114	152	229	306	381	457

### Notes

If offsets with ears are required, add one of the following suffixes to the product code:

Left Hand Side Offset /LE

Right Hand Side Offset /RE.

Products are available with either a red oxide primed coating, or pre-finished in satin black. Code references in the tables refer to primed products. For Pre-Finished products add the suffix /PA to the order code reference.

## 100mm Diameter Side Offsets, Plinth Offsets and Swan Necks

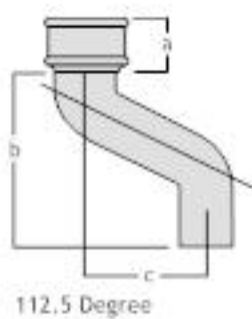

Code Ref	P40/OF/03	P40/OF/04	P40/OF/06	P40/OF/09	P40/OF/12	P40/OF/15	P40/OF/18
a	63	63	63	63	63	63	63
b	219	235	248	279	311	343	375
c	76	114	152	229	306	381	457



### Access Pipes

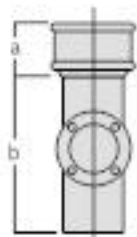

Code Ref	P25/AP	P30/AP	P40/AP
Pipe Diameter mm	63	76	102
Pipe Diameter inches	2 1/2"	3"	4"
a	63	63	63
b	343	343	343

### Diminishing Pieces

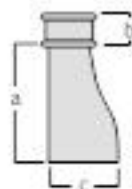

Code Ref	P40/DIM/25	P40/DIM/30
Pipe Diameter mm	100	100
Pipe Diameter inches	4"	4"
a	140	140
b	63	63
c	63	76

### Shoes

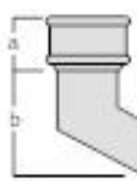

Regular



Anti-splash

Code Ref	Regular			Anti-splash		
	P25/SH	P30/SH	P40/SH	P25/SH/A	P30/SH/A	P40/SH/A
Pipe Diameter mm	63	76	102	63	76	102
Pipe Diameter inches	2 1/2"	3"	4"	2 1/2"	3"	4"
a	63	63	63	63	63	63
b	102	114	143	159	175	197
c	-	-	-	149	171	206

#### Notes

If shoes with ears are required, add one of the following suffixes to the product code:

Left Hand Side Shoe /L

Right Hand Side Shoe /R.

Products are available with either a red oxide primed coating, or pre-finished in satin black. Code references in the tables refer to primed products. For Pre-Finished products add the suffix /PA to the order code reference.

### Rainwater Heads

Code Ref	Flat Back			Corner			Rectangular		
	HH/001/25F	HH/001/30F	HH/001/40F	HH/001/25C	HH/001/30C	HH/001/40C	HH/002/25	HH/002/30	HH/003/40
Pipe Diameter mm	63	76	102	63	76	102	63	76	102
Pipe Diameter inches	2 1/2"	3"	4"	2 1/2"	3"	4"	2 1/2"	3"	4"
w	298	298	337	210	210	235	254	254	305
p	190	190	229	235	235	273	178	178	254
h	210	210	241	210	210	241	178	178	203

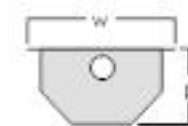

Flat Back

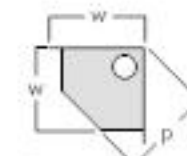

Corner



Rectangular

### Holderbats and Earbells

Note: Bracketry is available for all pipe sizes. Order codes should be prefixed by one of the following pipe types/sizes:

Round Pipes: P25, P30, P40

For example, P25/HB/CL – See page 15 for the relevant pipe table.

Contact Alumasc for further information.

#### Screw to wall holderbats



HB/CL



HB/GS

#### Built in holderbats



HB/BI



HB/ST

# Square Pipes

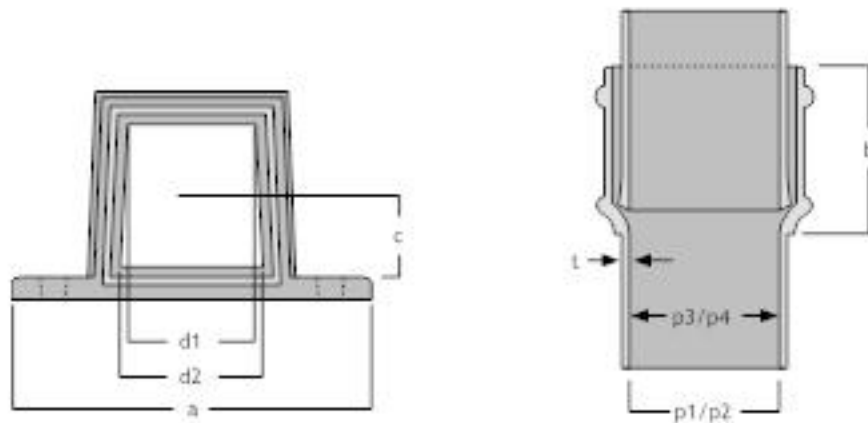

Sockets(Nominal)	75 x 75	100 x 75	100 x 100	125 x 100	150 x 100
A Width of flange	180	205	205	230	25
B Depth of socket	83	83	108	108	108
C Distance of centre to wall	50	50	65	65	65
D1 Internal dim. front	86	111	111	136.5	162
D2 Internal dim. back	89	114	114	140	165

Pipes (Nominal)	75 x 75	100 x 75	100 x 100	125 x 100	150 x 100
P1 External ø Front	82.5	108	108	133.5	159
P2 External ø Back	86	111	111	136.5	162
P3 Internal ø Front	70	95.5	95.5	121	146
P4 Internal ø Back	73	98.5	98.5	124	149
T Thickness	6.5	6.5	6.5	6.5	6.5

### Notes

- 1 Dimensions of rectangular pipes are given with the width as viewed from the front first, followed by the depth, front to back: eg 150 wide x 100 depth.
- 2 If ears are required, add suffix /E to the Ordering Reference.
- 3 If ears are required on single branches or swan-necks, please contact our Customer Services department for further details.
- 4 Shoes can also be used as side shoes. If side shoes with ears are required, add one of the following suffixes to the Ordering Reference according to its intended use:  
 \* lefthand side shoe /LE  
 \* righthand side shoe /RE.
- 5 Should projections other than those shown be required for swan-necks, plinth offsets or side offsets, please contact Alumasc Technical Services department for further details.
- 6 The majority of fittings illustrated in this section are available 'From stock'. However extended lead times might be required for some of them.
- 7 Products are available with either a red oxide primed coating, or pre-finished in satin black. Code references in the tables refer to primed products. For Pre-Finished products add the suffix /PA to the order code reference.



# Square Pipes and Fittings

A range of traditional cast iron socketed square and rectangular rainwater pipes in a choice of 5 pipe sizes and 2 pipe lengths. There is a comprehensive range of cast iron fittings and traditional earbelt fixings. Cast iron rainwater heads are also available to suit.



## Pipes

Pipe Length 0.914m

Code Ref	P33/3FT	P43/3FT	P44/3FT	P54/3FT	P64/3FT
Pipe Dimensions mm	75 x 75	100 x 75	100 x 100	125 x 100	150 x 100
Pipe Dimensions inches	3" x 3"	4" x 3"	4" x 4"	5" x 4"	6" x 4"

Pipe Length 1.83m

Code Ref	P33/6FT	P43/6FT	P44/6FT	P54/6FT	P64/6FT
Pipe Dimensions mm	75 x 75	100 x 75	100 x 100	125 x 100	150 x 100
Pipe Dimensions inches	3" x 3"	4" x 3"	4" x 4"	5" x 4"	6" x 4"

Note: Pipes are normally supplied eared. Where ears are not required, add suffix NE.

## 92.5 Degree Front/Back Bends

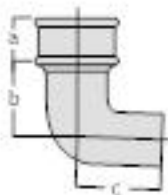

92.5 Degree

Code Ref	P33/B/92B/F*	P43/B/92B/F*	P44/B/92B/F*	P54/B/92B/F*	P64/B/92B/F*
Pipe Dimensions mm	75 x 75	100 x 75	100 x 100	125 x 100	150 x 100
Pipe Dimensions inches	3" x 3"	4" x 3"	4" x 4"	5" x 4"	6" x 4"
a	82	82	82	82	82
b	83	83	95	95	95
c	165	165	178	178	178

## 112.5 Degree Front/Back Bends

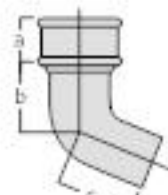

112.5 Degree

Code Ref	P33/B/112B/F*	P43/B/112B/F*	P44/B/112B/F*	P54/B/112B/F*	P64/B/112B/F*
Pipe Dimensions mm	75 x 75	100 x 75	100 x 100	125 x 100	150 x 100
Pipe Dimensions inches	3" x 3"	4" x 3"	4" x 4"	5" x 4"	6" x 4"
a	82	82	82	82	82
b	60	60	70	70	70
c	143	143	152	152	152

### Notes

If bends with ears are required, add suffix /E to the Product Code.

\*The order code for Heritage Cast Iron Front/Back bends should be suffixed F for Front or B for Back bends as appropriate.

Products are available with either a red oxide primed coating, or pre-finished in satin back. Code references in the tables refer to primed products. For Pre-Finished products add the suffix /PA to the order code reference.

## 135 Degree Front/Back Bends

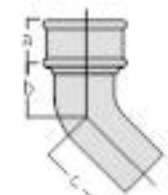

135 Degree

Code Ref	P33/B/135B/F*	P43/B/135B/F*	P44/B/135B/F*	P54/B/135B/F*	P64/B/135B/F*
Pipe Dimensions mm	75 x 75	100 x 75	100 x 100	125 x 100	150 x 100
Pipe Dimensions inches	3" x 3"	4" x 3"	4" x 4"	5" x 4"	6" x 4"
a	82	82	82	82	82
b	48	48	51	51	51
c	130	130	133	133	133

# Square Pipes and Fittings

## 92.5 Degree Bends

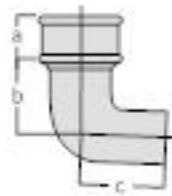

92.5 Degree

Code Ref	Left Bends					Right Bends				
	P33/B/92L	P43/B/92L	P44/B/92L	P54/B/92L	P64/B/92L	P33/B/92R	P43/B/92R	P44/B/92R	P54/B/92R	P64/B/92R
Pipe Dimensions mm	75 x 75	100 x 75	100 x 100	125 x 100	150 x 100	75 x 75	100 x 75	100 x 100	125 x 100	150 x 100
Pipe Dimensions inches	3" x 3"	4" x 3"	4" x 4"	5" x 4"	6" x 4"	3" x 3"	4" x 3"	4" x 4"	5" x 4"	6" x 4"
a	82	82	82	82	82	82	82	82	82	82
b	108	121	121	133	146	108	121	121	133	146
c	190	203	203	216	229	190	203	203	216	229

## 112.5 Degree Bends

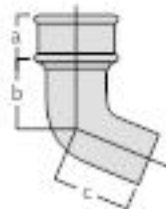

112.5 Degree

Code Ref	Left Bends					Right Bends				
	P33/B/112L	P43/B/112L	P44/B/112L	P54/B/112L	P64/B/112L	P33/B/112R	P43/B/112R	P44/B/112R	P54/B/112R	P64/B/112R
Pipe Dimensions mm	75 x 75	100 x 75	100 x 100	125 x 100	150 x 100	75 x 75	100 x 75	100 x 100	125 x 100	150 x 100
Pipe Dimensions inches	3" x 3"	4" x 3"	4" x 4"	5" x 4"	6" x 4"	3" x 3"	4" x 3"	4" x 4"	5" x 4"	6" x 4"
a	82	82	82	82	82	82	82	82	82	82
b	86	95	95	105	114	86	95	95	105	114
c	168	178	178	187	197	168	178	178	187	197



### Notes

If bends with ears are required, add suffix /E to the Product Code.

Products are available with either a red oxide primed coating, or pre-finished in satin back. Code references in the tables refer to primed products. For Pre-Finished products add the suffix /PA to the order code reference.

## 135 Degree Bends

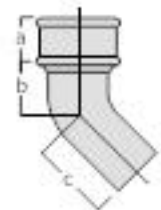

135 Degree

Code Ref	Left Bends					Right Bends				
	P33/B/135L	P43/B/135L	P44/B/135L	P54/B/135L	P64/B/135L	P33/B/135R	P43/B/135R	P44/B/135R	P54/B/135R	P64/B/135R
Pipe Dimensions mm	75 x 75	100 x 75	100 x 100	125 x 100	150 x 100	75 x 75	100 x 75	100 x 100	125 x 100	150 x 100
Pipe Dimensions inches	3" x 3"	4" x 3"	4" x 4"	5" x 4"	6" x 4"	3" x 3"	4" x 3"	4" x 4"	5" x 4"	6" x 4"
a	82	82	82	82	82	82	82	82	82	82
b	73	76	76	83	89	73	76	76	83	89
c	156	158	158	165	171	156	158	158	165	171

### 92.5 Degree Branches

Code Ref	Left Branches					Right Branches				
	P33/BR/92L	P43/BR/92L	P44/BR/92L	P54/BR/92L	P64/BR/92L	P33/BR/92R	P43/BR/92R	P44/BR/92R	P54/BR/92R	P64/BR/92R
Pipe Dimensions mm	75 x 75	100 x 75	100 x 100	125 x 100	150 x 100	75 x 75	100 x 75	100 x 100	125 x 100	150 x 100
Pipe Dimensions inches	3" x 3"	4" x 3"	4" x 4"	5" x 4"	6" x 4"	3" x 3"	4" x 3"	4" x 4"	5" x 4"	6" x 4"
a	82	82	82	82	82	82	82	82	82	82
b	273	298	298	324	349	273	298	298	324	349
c	83	98	98	111	124	83	98	98	111	124

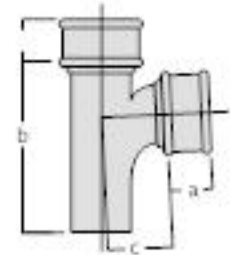

92.5 Degree

### 112.5 Degree Branches

Code Ref	Left Branches					Right Branches				
	P33/BR/112L	P43/BR/112L	P44/BR/112L	P54/BR/112L	P64/BR/112L	P33/BR/112R	P43/BR/112R	P44/BR/112R	P54/BR/112R	P64/BR/112R
Pipe Dimensions mm	75 x 75	100 x 75	100 x 100	125 x 100	150 x 100	75 x 75	100 x 75	100 x 100	125 x 100	150 x 100
Pipe Dimensions inches	3" x 3"	4" x 3"	4" x 4"	5" x 4"	6" x 4"	3" x 3"	4" x 3"	4" x 4"	5" x 4"	6" x 4"
a	82	82	82	82	82	82	82	82	82	82
b	273	298	298	324	349	273	298	298	324	349
c	102	121	121	146	159	102	121	121	146	159

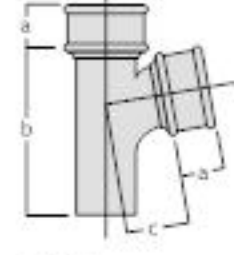

112.5 Degree

**Notes**

If single branches with ears are required, add suffix /E to the Product Code.

Products are available with either a red oxide primed coating, or pre-finished in satin back. Code references in the tables refer to primed products. For Pre-Finished products add the suffix /PA to the order code reference.

### 135 Degree Branches

Code Ref	Left Branches					Right Branches				
	P33/BR/135L	P43/BR/135L	P44/BR/135L	P54/BR/135L	P64/BR/135L	P33/BR/135R	P43/BR/135R	P44/BR/135R	P54/BR/135R	P64/BR/135R
Pipe Dimensions mm	75 x 75	100 x 75	100 x 100	125 x 100	150 x 100	75 x 75	100 x 75	100 x 100	125 x 100	150 x 100
Pipe Dimensions inches	3" x 3"	4" x 3"	4" x 4"	5" x 4"	6" x 4"	3" x 3"	4" x 3"	4" x 4"	5" x 4"	6" x 4"
a	82	82	82	82	82	82	82	82	82	82
b	340	375	375	416	451	340	375	375	416	451
c	146	175	175	203	235	146	175	175	203	235

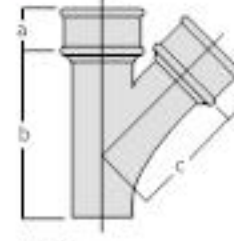

135 Degree

# Square Pipes and Fittings

## 75 x 75mm Side Offsets, Plinth Offsets and Swan Necks

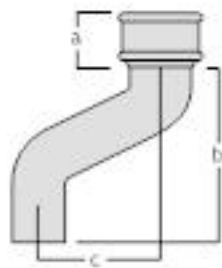

112.5 Degree

112.5 Degree Left Hand Offsets

Code Ref	P33/OF/03L	P33/OF/04L	P33/OF/06L	P33/OF/09L	P33/OF/12L	P33/OF/15L	P33/OF/18L
a	82	82	82	82	82	82	82
b	286	302	317	349	381	413	444
c	76	114	152	228	305	381	457

112.5 Degree Right Hand Offsets

Code Ref	P33/OF/03R	P33/OF/04R	P33/OF/06R	P33/OF/09R	P33/OF/12R	P33/OF/15R	P33/OF/18R
a	82	82	82	82	82	82	82
b	286	302	317	349	381	413	444
c	76	114	152	228	305	381	457

120 Degree Swan Neck

Code Ref	P33/OF/03	P33/OF/04	P33/OF/06	P33/OF/09	P33/OF/12	P33/OF/15	P33/OF/18
a	82	82	82	82	82	82	82
b	286	302	317	349	381	413	444
c	76	114	152	228	305	381	457

135 Degree Plinth Offset

Code Ref	P33/OF/02P	P33/OF/03P	P33/OF/04P	P33/OF/06P
a	82	82	82	82
b	317	330	368	-
c	63	76	114	152

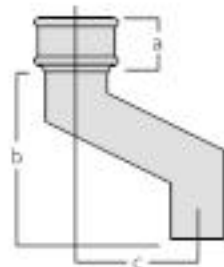

120 Degree

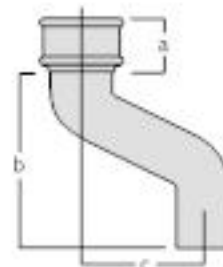

135 Degree

### Notes

If ears are required on 112.5° and 135° offsets, add suffix /E to the Product Code.  
 Products are available with either a red oxide primed coating, or pre-finished in satin back. Code references in the tables refer to primed products. For Pre-Finished products add the suffix /PA to the order code reference.

## 100 x 75mm Side Offsets, Plinth Offsets and Swan Necks

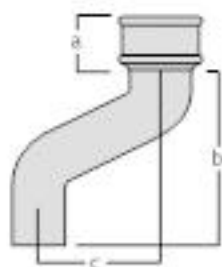

112.5 Degree

112.5 Degree Left Hand Offsets

Code Ref	P43/OF/03L	P43/OF/04L	P43/OF/06L	P43/OF/09L	P43/OF/12L	P43/OF/15L	P43/OF/18L
a	82	82	82	82	82	82	82
b	302	317	333	365	397	429	460
c	76	114	152	228	305	381	457

112.5 Degree Right Hand Offsets

Code Ref	P43/OF/03R	P43/OF/04R	P43/OF/06R	P43/OF/09R	P43/OF/12R	P43/OF/15R	P43/OF/18R
a	82	82	82	82	82	82	82
b	302	317	333	365	397	429	460
c	76	114	152	228	305	381	457

120 Degree Swan Neck

Code Ref	P43/OF/03	P43/OF/04	P43/OF/06	P43/OF/09	P43/OF/12	P43/OF/15	P43/OF/18
a	82	82	82	82	82	82	82
b	302	317	333	365	397	429	460
c	76	114	152	228	305	381	457

135 Degree Plinth Offset

Code Ref	P43/OF/02P	P43/OF/03P	P43/OF/04P	P43/OF/06P
a	82	82	82	82
b	317	330	368	406
c	63	76	114	152

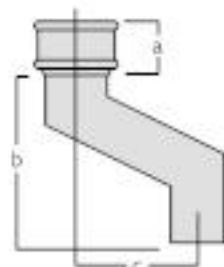

120 Degree

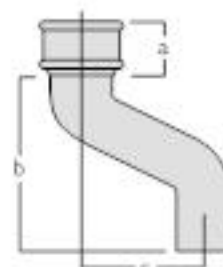

135 Degree

### 100 x 100 mm Side Offsets, Plinth Offsets and Swan Necks

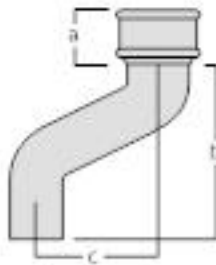

112.5 Degree

112.5 Degree Left Hand Offsets

Code Ref	P44/OF/03L	P44/OF/04L	P44/OF/06L	P44/OF/09L	P44/OF/12L	P44/OF/15L	P44/OF/18L
a	82	82	82	82	82	82	82
b	302	317	333	365	397	429	460
c	76	114	152	228	305	381	457

112.5 Degree Right Hand Offsets

Code Ref	P44/OF/03R	P44/OF/04R	P44/OF/06R	P44/OF/09R	P44/OF/12R	P44/OF/15R	P44/OF/18R
a	82	82	82	82	82	82	82
b	302	317	333	365	397	429	460
c	76	114	152	228	305	381	457

120 Degree Swan Neck

Code Ref	P44/OF/03	P44/OF/04	P44/OF/06	P44/OF/09	P44/OF/12	P44/OF/15	P44/OF/18
a	82	82	82	82	82	82	82
b	302	317	333	365	397	429	460
c	76	114	152	228	305	381	457

135 Degree Plinth Offset

Code Ref	P44/OF/02P	P44/OF/03P	P44/OF/04P	P44/OF/06P
a	82	82	82	82
b	324	340	375	416
c	63	76	114	152

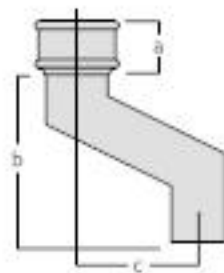

120 Degree

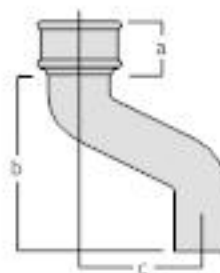

135 Degree

**Notes**

If ears are required on 112.5° and 135° offsets, add suffix /E to the Product Code.

Products are available with either a red oxide primed coating, or pre-finished in satin back. Code references in the tables refer to primed products. For Pre-Finished products add the suffix /PA to the order code reference.

### 125 x 100mm Side Offsets, Plinth Offsets and Swan Necks

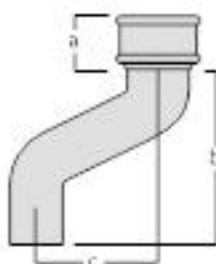

112.5 Degree

112.5 Degree Left Hand Offset

Code Ref	P54/OF/03L	P54/OF/04L	P54/OF/06L	P54/OF/09L	P54/OF/12L	P54/OF/15L	P54/OF/18L
a	82	82	82	82	82	82	82
b	317	333	349	381	413	444	476
c	76	114	152	228	305	381	457

112.5 Degree Right Hand Offset

Code Ref	P54/OF/03R	P54/OF/04R	P54/OF/06R	P54/OF/09R	P54/OF/12R	P54/OF/15R	P54/OF/18R
a	82	82	82	82	82	82	82
b	317	333	349	381	413	444	476
c	76	114	152	228	305	381	457

120 Degree Swan Neck

Code Ref	P54/OF/03	P54/OF/04	P54/OF/06	P54/OF/09	P54/OF/12	P54/OF/15	P54/OF/18
a	82	82	82	82	82	82	82
b	317	333	349	381	413	444	476
c	76	114	152	228	305	381	457

135 Degree Plinth Offset

Code Ref	P54/OF/02P	P54/OF/03P	P54/OF/04P	P54/OF/06P
a	82	82	82	82
b	324	340	375	416
c	63	76	114	152

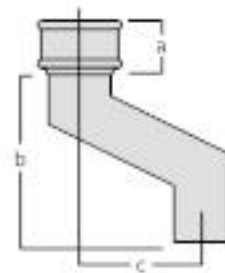

120 Degree

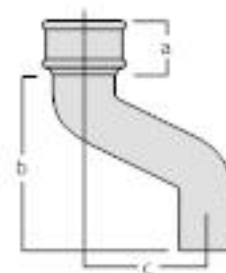

135 Degree

# Square Pipes and Fittings

## 150 x 100mm Side Offsets, Plinth Offsets and Swan Necks

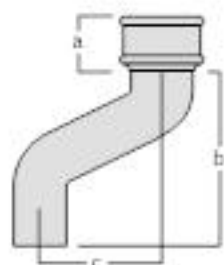

112.5 Degree

112.5 Degree Left Hand Offset

Code Ref	P64/OF/03L	P64/OF/04L	P64/OF/06L	P64/OF/09L	P64/OF/12L	P64/OF/15L	P64/OF/18L
a	82	82	82	82	82	82	82
b	337	352	368	400	432	464	495
c	76	114	152	228	305	381	457

112.5 Degree Right Hand Offset

Code Ref	P64/OF/03R	P64/OF/04R	P64/OF/06R	P64/OF/09R	P64/OF/12R	P64/OF/15R	P64/OF/18R
a	82	82	82	82	82	82	82
b	337	352	368	400	432	464	495
c	76	114	152	228	305	381	457

120 Degree Swan Neck

Code Ref	P64/OF/03	P64/OF/04	P64/OF/06	P64/OF/09	P64/OF/12	P64/OF/15	P64/OF/18
a	82	82	82	82	82	82	82
b	337	352	368	400	432	464	495
c	76	114	152	228	305	381	457

135 Degree Plinth Offset

Code Ref	P64/OF/02P	P64/OF/03P	P64/OF/04P	P64/OF/06P
a	82	82	82	82
b	324	340	375	416
c	63	76	114	152

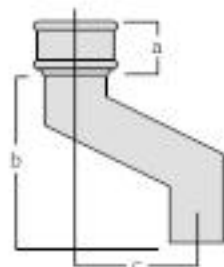

120 Degree

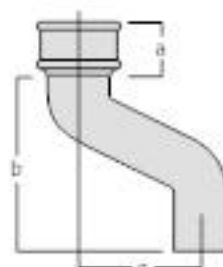

135 Degree

### Notes

If ears are required on 112.5° and 135° offsets, add suffix /E to the Product Code.

Products are available with either a red oxide primed coating, or pre-finished in satin back. Code references in the tables refer to primed products. For Pre-Finished products add the suffix /PA to the order code reference.

## Front Right Hand/Left Hand Shoes

Code Ref	P33/SH	P43/SH	P44/SH	P54/SH	P64/SH
Pipe Dimensions mm	75 x 75	100 x 75	100 x 100	125 x 100	150 x 100
Pipe Dimensions inches	3" x 3"	4" x 3"	4" x 4"	5" x 4"	6" x 4"
a	82	82	82	82	82
b	159	159	184	184	184

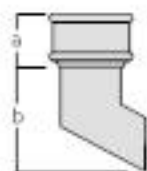

Front Right Hand/  
Left Hand

## Anti-splash Shoes

Code Ref	P33/SH/A	P43/SH/A	P44/SH/A	P54/SH/A	P64/SH/A
Pipe Dimensions mm	75 x 75	100 x 75	100 x 100	125 x 100	150 x 100
Pipe Dimensions inches	3" x 3"	4" x 3"	4" x 4"	5" x 4"	6" x 4"
a	82	82	82	82	82
b	216	216	216	216	216
c	171	171	197	197	197



Note: Shoes can also be used as side shoes. Add one of the following suffixes to the Ordering Reference according to its intended use:  
left hand side shoe /L  
right hand side shoe /R.  
If ears are required, add suffix /E to the Ordering Reference.



### Rainwater Heads

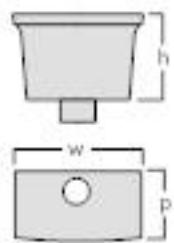

Code Ref	HH/002/33	HH/002/43	HH/003/43	HH/002/44	HH/003/44	HH/003/54
Pipe Dimensions mm	75 x 75	100 x 75	100 x 75	100 x 100	100 x 100	125 x 100
Pipe Dimensions inches	3" x 3"	4" x 3"	4" x 3"	4" x 4"	4" x 4"	5" x 4"
w	254	254	304	254	304	304
p	178	178	254	178	254	254
h	178	178	302	178	302	302

### Square to Circular Connector

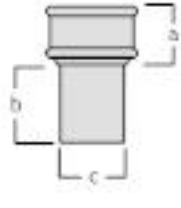

Code Ref	P33/C	P43/C	P44/C	P54/C	P64/C
Pipe Dimensions mm	75 x 75	100 x 75	100 x 100	125 x 100	150 x 100
Pipe Dimensions inches	3" x 3"	4" x 3"	4" x 4"	5" x 4"	6" x 4"
a	83	83	83	83	83
b	95	95	95	95	95
c	108	108	108	108	108

#### Notes

If ears are required on 112.5° and 135° offsets, add suffix /E to the Product Code.

Products are available with either a red oxide primed coating, or pre-finished in satin back. Code references in the tables refer to primed products. For Pre-Finished products add the suffix /PA to the order code reference.

### Corner Shoes

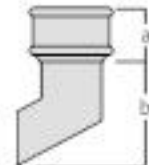

Code Ref	P33/SH/C	P44/SH/C
Pipe Dimensions mm	75 x 75	100 x 100
Pipe Dimensions inches	3" x 3"	4" x 4"
a	82	82
b	187	229

Corner

# Square Pipes and Fittings

## Holderbats and Earbelts

**Note**

Bracketry is available for all pipe sizes. Order codes should be prefixed by one of the following pipe types/sizes:

Square/Rectangular Pipes: P33, P43, P44, P54, P64

For example, P33/EB/E6 – See page 22 for the relevant pipe tables.

Contact Alumasc for further information.



EB/E12



EB/E21



EB/E15



EB/E7



EB/E10



EB/E9



EB/E20



EB/E3



EB/E13



EB/E4



EB/E6



PC/CL



PC/ST



# Made to Order

## Made to Order



The versatility of the Alumasc offer is further enhanced by the compatibility between the Heritage stock ranges and made to order products.

- Made to order products can be used in conjunction with stock pipes and fittings.
- Made to order products are fully compatible with metal fascia and drive brackets, and other fixings from the stock ranges.

Once a pattern has been made, products to that pattern can be repeated on a made to order basis.

Every bespoke project adds to the inventory of patterns, which in turn enables Alumasc to continually increase the number of designs it can offer.

Alumasc aims to make available to the specifier and builder a service whereby an existing installation can be replaced with an exact match however obscure the pattern.

### Introduction

Cast iron has been used in Britain for more than 500 years and this, combined with its great versatility, means that no standard product range can hope to satisfy all the stylistic options for new building, nor address the challenges of exact replacement for refurbishment and restoration. Apex Heritage Cast Iron Made to Order is specifically designed to meet these needs.



## Gutters

Gutters can be made to order in any shape – half round, box, ogee or moulded. Radiused gutters can also be produced. All are available with fittings to accommodate any situation: 90° external or internal angle, running outlet, union clip or LH stopend (inside gutter).

Please contact us for more information.

## Half Round Gutters

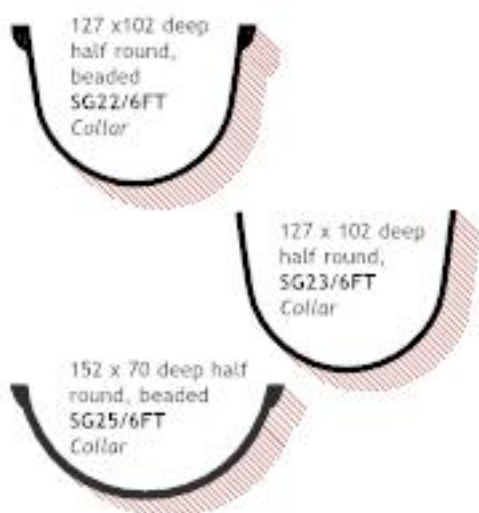

## Box Gutters

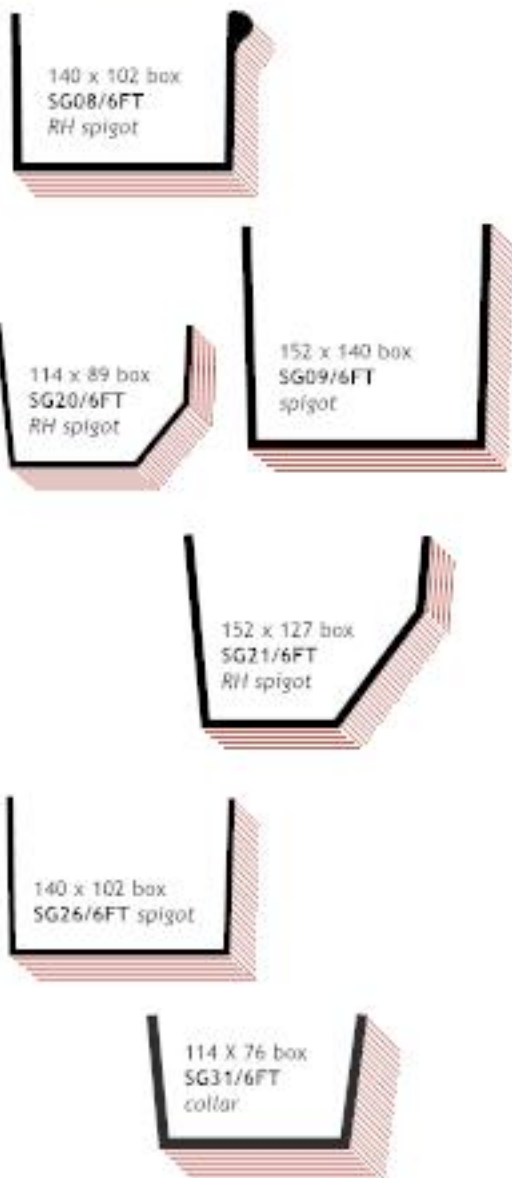

## Ogee Gutters

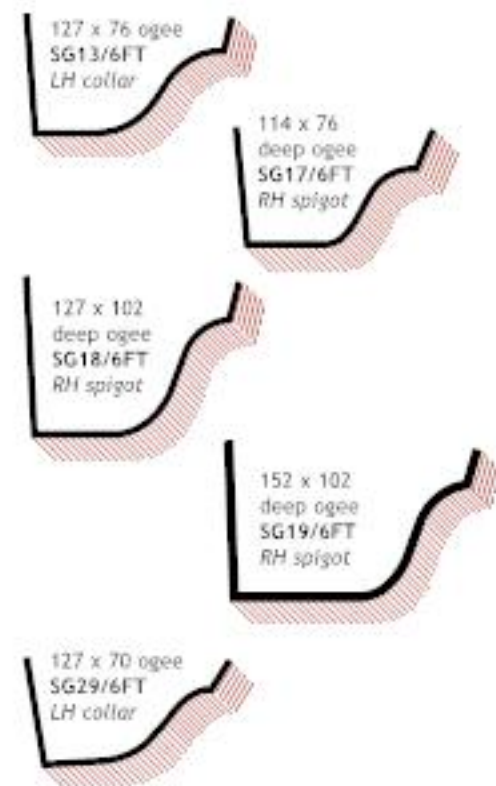

## Moulded Gutters

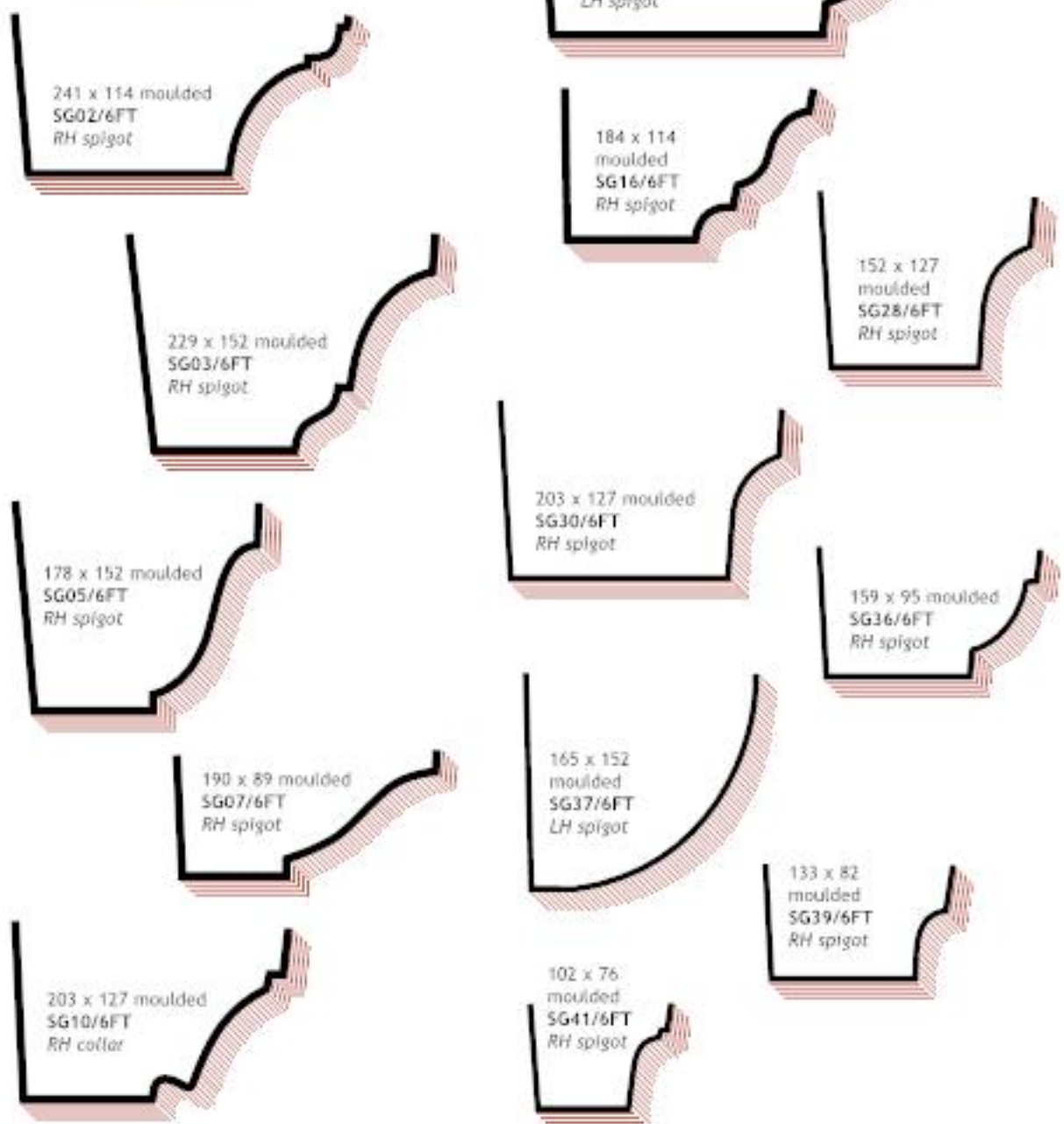

## Made to Order

### Rainwater Heads



Code	Circular outlets up to	Rectangular outlets up to	W	H
11	102	127 x 102	444	368
12	102	102 x 102	356	305
17	76	-	267	260
34	152	152 x 102	451	380
40	102	102 x 102	2 shapes	305
42	152	152 x 102	3 sizes	152
61	102	127 x 102	457	165
62	102	127 x 102	476	610
82	152	152 x 102	3 sizes	229
91	76	76 x 76	356	343
97	102	102 x 102	2 shapes	292
131	127	127 x 102	476	210
132	127	127 x 102	381	406
169	76	102 x 102	298	210
170	102	102 x 102	419	152
301	-	76 x 76	250	381
302	-	127 x 102	584	508
303	-	102 x 76	203	330
304	102	-248	368	
305	-	102 x 76	317	451
306	-	102 x 76	762	451

Note: W = Overall width H = Height excluding spigot.

This page shows the Apex Heritage made to order range of decorative rainwater heads. These products are readily available because Alumasc holds the patterns and can produce the items to order.

The number of available made to order designs increases as additional patterns are created for new commissions.

A variety of different designs is possible for decorative earbelts, and additional enrichments can be incorporated into the rainwater heads shown.

### Enrichments



# Installation and Specification

# Installation

## Generally

BS 8000 Workmanship on building sites, Part 13 Code of Practice for above ground drainage and sanitary appliances: 1989 is relevant in general terms.

## Health and Safety

Always refer to current Health and Safety legislation, safe systems of work and the relevant materials safety data sheets.

## Imperial Dimensions

All products in the Apex Heritage Cast Iron range are manufactured to conform with original imperial dimensions which assist where an existing installation is being required or being replaced. Fixing holes can be reused, thereby saving not only time but the building from unsightly repair. The original building fabric is also left undamaged, an important consideration when dealing with historic buildings.

## Gutter Falls

Where possible a fall of 1:600 to 1:350 (maximum) should be allowed for. However, gutters can be laid level if this is not possible. In replacement work falls up to 1:254 may occur, and are permissible on small buildings.

## Gutter Fixing

Outlets and rainwater heads should be positioned first, followed by the interlinking gutter section. For slated roofs, the gutter may be placed with the centre line under the drip edge, but on pantile roofs the gutter should be set slightly further out. Gutters should be supported at 900mm approximate centres either on brackets or, for ogee, moulded and box types, by direct screw fixing through the back of the gutter.

Gutter profile	Cast iron fascia bracket fixing	Direct fix
Half round	No.10 x 1 1/2" imperial or 5 x 40mm metric roundhead screw	n/a
Beaded half round	No.10 x 1 1/2" imperial or 5 x 40mm metric roundhead screw	n/a
Ogee	No.10 x 1 1/2" imperial or 5 x 40mm metric roundhead screw	No.10 x 1 1/2" imperial or 5 x 40mm metric roundhead screw
Moulded	No.12 x 1 1/2" imperial or 6 x 40mm metric roundhead screw	No.12 x 1 1/2" imperial or 6 x 40mm metric roundhead screw
		Moulded gutters 125 x 100mm (5 x 4") and above should be supported using additional brackets e.g. L-shaped brackets

### Note

Ogee and moulded gutter profiles in direct fix installations should be supported using a small spacer batten on the fascia board to ensure the base of the gutter is level.

Securely fixed fascia boards must be painted and capable of supporting a fully loaded gutter. Additional brackets or fixings should be provided at angles and outlets to prevent the risk of sagging under snow load. When fixing through the back of the gutter the screws should be tensioned gently and evenly to avoid damaging the gutter.

## Gutter Jointing

Sections of gutter are bolted together with a galvanised gutter bolt and nut M6 x 20 or 25mm depending on gutter profile.

Gutter joints are made watertight with a suitable high quality low modulus sealant (recommended Dow Corning 791).

For half round gutters (nominal sizes 100, 115 and 125mm – 150mm available on request) the unique Alumasc Hydrostrip system is recommended. The Hydrostrip system comprises preformed rubber seals that are quick and easy to install, and totally reliable. Hydrostrip offers a faster and cleaner solution to gutter jointing than traditional mastic jointing sealants. With Hydrostrip, joints can be made in damp conditions and can be overpainted immediately.

Hydrostrip is supplied complete with screws, nuts and installation instructions in kits containing 20 jointing sets. Hydrostrip is not suited for use with Beaded Half Round gutters.

### Note

It is no longer common practice to overlap the collar and spigot joints in the direction of flow.





## Downpipe Fixing

Rainwater pipes are fixed back to the wall at 1.830m (6ft) approximate centres through ears integral with the pipe, or via separate earbelt or holderbats. It is recommended that the fixing should penetrate at least 50mm into the wall. Screws or pipe nails should be galvanised. Pipe nails are available 100mm long.

Preformed fixing holes through the ears are approximately 8mm diameter. Screws should be round or dome headed galvanised, using 18mm to 25mm diameter washers.

Bobbins can be used to pack out the rainwater pipe fixing to give a 32mm maintenance gap for pipes up to 75mm (3") diameter, and 38mm for 100mm (4") pipes.

Rainwater heads should be fixed back to the wall using galvanised screws and washers through the preformed holes. Proprietary fixings are also available from manufacturers such as Rawlplug, Hilti and Fischer Fixings.

## Downpipe Jointing

Generally the joints between sections of rainwater pipe are not completely sealed. On Apex Heritage Cast Iron they are simply wedged with several lead slips 25mm wide to prevent any lateral movement. These slips should be knocked down into the 3mm-4mm gap between the outer face of the pipe and inside face of the collar, so that they are no longer visible. However where pipes are of small capacity which cannot be increased they should be both wedged and sealed with high quality sealant against a backing strip.

## Site Cutting

Cast iron can be cut and drilled on site with metalworking tools. Site-cut ends and drilled holes exposing bare metal must be de-burred and then repainted in accordance with Alumasc's site painting procedure.

## Painting and Finish

Apex Heritage cast iron rainwater products are supplied either factory-primed or pre-finished.

### Factory-primed

Alumasc supplies cast iron products factory primed with one coat of protective red oxide primer. This primer will give protection against corrosion during transportation and short-term undercover storage, and will provide a suitable surface for final painting. On-site handling and painting are the responsibility of the contractor, and particular environmental considerations should be taken into account when choosing the paint system for final finishing.

Alumasc recommends that on site a further priming coat be applied, followed by 1 undercoat and 2 gloss coats of an alkyd paint system. All individual elements should receive the first of the gloss coats before fixing, and finished with the final gloss coat after the installation is complete. All exposed surfaces must be treated in this way. It is advisable to take the paint finish inside collars and within the ends of rainwater pipes to avoid the possibility of rust staining.



### Pre-finished

Pre-finished products utilise a threecoat system, which has been specifically developed for cast iron, to provide a smooth and long-lasting finish. Alumasc offers the most comprehensive range of pre-finished traditional sand cast iron in the UK, including all components such as union clips, stop ends, outlets, angles, brackets, pipe bands, diminishing pieces, branches, offsets, access pipes and shoes, plus rainwater heads and sockets - a complete ready to install integrated system.

# Specification

## Model Specification

### Gutters

Alumasc Apex Heritage Cast Iron gutters and fixings in accordance with British Standard as appropriate. size..... profile..... Factory-primed/Pre-finished\* Ordering reference..... Outlet Size..... shape..... Gutters to be fixed at 900mm approximate centres, fixings with..... type brackets/direct screwed\* to fascia. All manufactured by Alumasc Exterior Building Products Ltd, White House Works, Bold Road, Sutton, St Helens, Merseyside WA9 4JG.

\* Delete as necessary.

### Installation - Gutters

Gutters to be laid to a..... fall generally in accordance with BS 8000: Part 13.\*

Gutters to be laid flat with no fall.\*

Gutter joints to be sealed with..... sealant and bolted with M6x..... mm gutter bolts and nuts.\*

Gutter joints to be sealed with Alumasc Hydrostrip dry jointing system (half round only).\*

Gutters and fixings to be site primed, undercoated and painted with one finish coat before installation with final finish coat after.

\* Delete as necessary.

### Downpipes

Alumasc Apex Heritage Cast Iron downpipes and fittings in accordance with British Standard as appropriate.

Pipes size..... shape..... pipes. Factory-primed/Pre-finished\* without ears/with ears, Ordering reference..... pipes to be fixed with..... at..... centres through ears/earbelts/holderbats:\* Ordering reference..... Bobbins..... thick to be used to space the pipes off the wall.

Rainwater Heads Ordering reference..... flat/corner type: size.....

Outlet size..... shape..... Rainwater heads to be fixed with.....

Additional enrichments: Ordering reference.....

All manufactured by Alumasc Exterior Building Products Ltd, White House Works, Bold Road, Sutton, St Helens, Merseyside WA9 4JG.

\* Delete as necessary.

### Installation - Downpipes

Generally to be in accordance with BS 8000: Part 13. Pipes to be left unsealed but wedged with lead slips against movement.\*

Pipes to be sealed with..... sealant against a..... backing strip.\*

Pipes and pipe fixings to be site primed, undercoated and painted with one finish coat before installation with the final coat after.

\* Delete as necessary.

### Rainwater heads

Ordering Reference..... flat/corner type; size.....

Outlet size..... shape..... Rainwater head/s to be fixed with.....

Additional enrichment/s; Ordering Reference.....

All manufactured by Alumasc Exterior Building Products Limited.

### Installation - Rainwater Heads

Rainwater heads, including the inside, to be site primed, undercoated and painted with one finish coat before installation, with the final finish coat after.

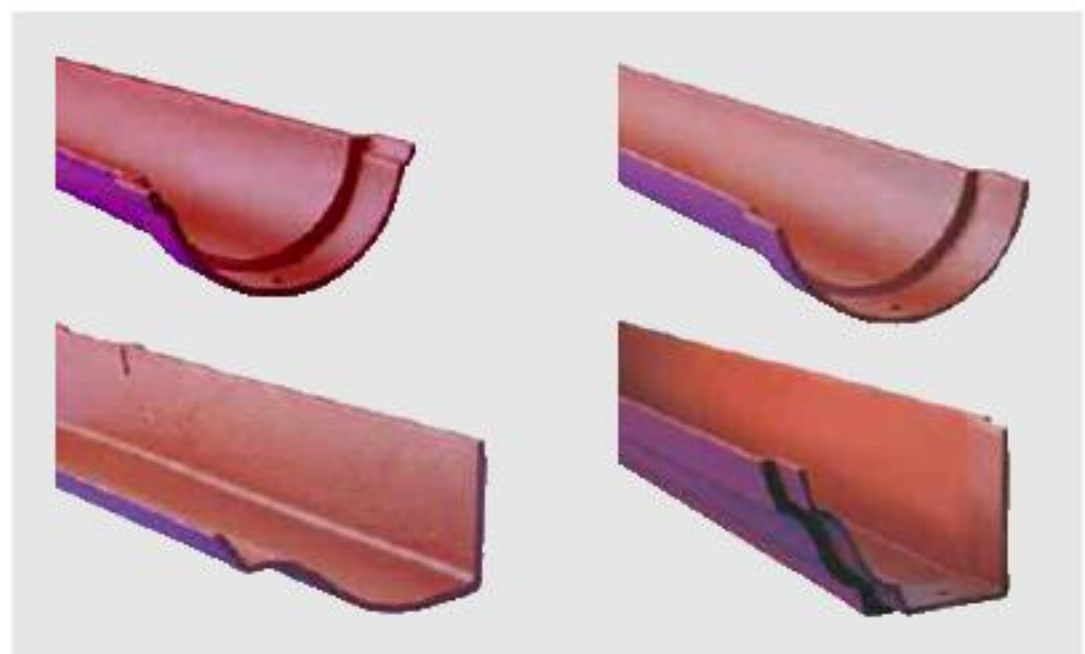

## Care and maintenance

### Routine inspection

Regularly clean out rainwater heads and gutters and ensure that downpipes are clear at all times. Check that joints and fixings are secure by periodic inspection, not less than twice a year, and preferably at the beginning of Autumn and again at the end of Winter. Sand-cast iron is an inherently durable material, and with a reasonable standard of maintenance, an installation should have a life of at least 40 years.

### Ladders

Even with a well fixed installation, ladders should not be rested against the gutters.

### Repainting

The final paint finish on factory-primed cast iron must be maintained to give the longest service life. A well applied paint system might be expected to last from 5 to 7 years on cast iron without further attention. Regular inspection is recommended.

It is recommended that pre-finished cast iron is maintained as above. It is important that any installation damage to the coating is repaired with the appropriate touch-up paint. Any cut pieces exposing bare metal must be coated with primer and top coat.

### Other maintenance operations

When cleaning adjacent surfaces, cast iron should be protected against all acids and concentrated alkalis.

## Conversion Tables

The imperial to metric conversions that are given on this page are intended to assist the specifier with comparative dimensioning between new and original gutters where replacement of rainwater systems in whole or in part is necessary.

in	ft in	mm	in	ft in	in	mm
1/8		3.2	8 1/8			206.4
1/4		6.4	8 1/4			209.6
3/8		9.5	8 3/8			212.7
1/2		12.7	8 1/2			215.9
5/8		15.9	8 5/8			219.1
3/4		19.1	8 3/4			222.3
7/8		22.2	8 7/8			225.4
1		25.4	9			228.6
1 1/8		28.6	9 1/8			231.8
1 1/4		31.8	9 1/4			235.0
1 3/8		34.9	9 3/8			238.1
1 1/2		38.1	9 1/2			241.3
1 5/8		41.3	9 5/8			244.5
1 3/4		44.5	9 3/4			247.7
1 7/8		47.6	9 7/8			250.8
2		50.8	10			254.0
2 1/8		54.0	10 1/8			257.2
2 1/4		57.2	10 1/4			260.4
2 3/8		60.3	10 3/8			263.5
2 1/2		63.5	10 1/2			266.7
2 5/8		66.7	10 5/8			269.9
2 3/4		69.9	10 3/4			273.1
2 7/8		73.0	10 7/8			276.2
3		76.2	11			279.4
3 1/8		79.4	11 1/8			282.6
3 1/4		82.6	11 1/4			285.8
3 3/8		85.7	11 3/8			288.9
3 1/2		88.9	11 1/2			292.1
3 5/8		92.1	11 5/8			295.3
3 3/4		95.3	11 3/4			298.5
3 7/8		98.4	11 7/8			301.6
4		101.6	12	1	0	304.8
4 1/8		104.8	12 1/8	1	0 1/8	308.0
4 1/4		108.0	12 1/4	1	0 1/4	311.2
4 3/8		111.1	12 3/8	1	0 3/8	314.3
4 1/2		114.3	12 1/2	1	0 1/2	317.5
4 5/8		117.5	12 5/8	1	0 5/8	320.7
4 3/4		120.7	12 3/4	1	0 3/4	323.9
4 7/8		123.8	12 7/8	1	0 7/8	327.0
5		127.0	13	1	1	330.2
5 1/8		130.2	13 1/8	1	1 1/8	333.4
5 1/4		133.4	13 1/4	1	1 1/4	336.6
5 3/8		136.5	13 3/8	1	1 3/8	339.7
5 1/2		139.7	13 1/2	1	1 1/2	342.9
5 5/8		142.9	13 5/8	1	1 5/8	346.1
5 3/4		146.1	13 3/4	1	1 3/4	349.3
5 7/8		149.2	13 7/8	1	1 7/8	352.4
6		152.4	14	1	2	355.6
6 1/8		155.6	14 1/8	1	2 1/8	358.8
6 1/4		158.8	14 1/4	1	2 1/4	362.0
6 3/8		161.9	14 3/8	1	2 3/8	365.1
6 1/2		165.1	14 1/2	1	2 1/2	368.3
6 5/8		168.3	14 5/8	1	2 5/8	371.5
6 3/4		171.5	14 3/4	1	2 3/4	374.7
6 7/8		174.6	14 7/8	1	2 7/8	377.8
7		177.8	15	1	3	381.0
7 1/8		181.0	15 1/8	1	3 1/8	384.2
7 1/4		184.2	15 1/4	1	3 1/4	387.4
7 3/8		187.3	15 3/8	1	3 3/8	390.5
7 1/2		190.5	15 1/2	1	3 1/2	393.7
7 5/8		193.7	15 5/8	1	3 5/8	396.9
7 3/4		196.9	15 3/4	1	3 3/4	400.1
7 7/8		200.0	15 7/8	1	3 7/8	403.2
8		203.2	16	1	4	406.4

premium products • proven solutions

-  Rainwater
-  Drainage
-  Waterproofing
-  Façades

ALUMASC EXTERIOR BUILDING PRODUCTS LTD  
White House Works, Bold Road, Sutton,  
St Helens, Merseyside, WA9 4JG  
United Kingdom  
Telephone: +44 (0)1744 648400  
Facsimile: +44 (0)1744 648401  
Website: [www.alumascrainwater.co.uk](http://www.alumascrainwater.co.uk)  
E-mail: [info@alumasc-exteriors.co.uk](mailto:info@alumasc-exteriors.co.uk)

Technical Support  
+44 (0)1744 648 400

Literature Hotline  
+44 (0)808 100 2008



Printed on 80%  
recycled paper stock

All reasonable care has been taken in the preparation of this brochure, all information, recommendations and guidance notes on the use of The Products are made without guarantee since the conditions of use are beyond the control of Alumasc Exterior Building Products Limited (The Company). The customer is responsible for ensuring that each product is fit for its intended purpose and that conditions for use are suitable.

The information contained in this brochure and advice arising therefrom is free of charge and accordingly on the terms that no liability nor liability for negligence will attach to The Company or its servants in relation to any such service arising out of or in connection with this brochure.

The Company pursues a policy of constant product development and information contained in this publication is therefore subject to change without notice.