

## Subfloors

### AltroPol™

AltroPol improves the strength of subfloors in readiness to receive resilient flooring systems or synthetic resin floor finishes.

AltroPol is a stabilised polymer designed to enhance the physical properties of cement based floor screeds and repair compounds. It contains integral antifoam and antioxidant agents.

AltroPol greatly improves flexural strength which, together with the high bonding and fast-curing capacity, allows the production of thin section seamless floor screeds with excellent durability and overall properties.

AltroPol is supplied as a white mobile liquid. It is readily diluted with water and then used to gauge the screed mixture of cement and aggregates to provide the desired levels of performance.

### Thickness

The minimum recommended design thicknesses are as follow:

- 6mm Bonded
- 50mm Unbonded
- 75mm Floating

### Areas of use

#### Typical applications

- Faster curing to allow early overlayment
- Thin section floor screeds
- Smoothing screeds to even out the surface of damaged or tamped finish concrete
- Levelling screeds to receive other finishes
- Screeds of varying thickness to install falls for drainage purposes
- Underlayments for resilient floor coverings and resin finishes
- Patching of worn or damaged concrete

#### Benefits

- Greatly reduced drying time
- Easy to use single component, gauged as required
- Thinner screeds with excellent durability and impact resistance
- Superb adhesion, maintained even in wet conditions
- Integral antifoam so no additions on site are necessary

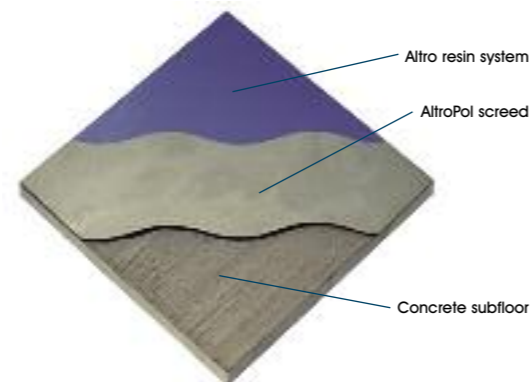

## Humidity range/relative humidity (RH)

### AltroProof Duo™ Up to 97%

- Two coat, two part epoxy system
- 6 hour cure time between coats
- Excellent adhesion under adverse conditions
- Excellent resistance to water and hydrolysis

### AltroProof Solo™ Up to 95%

- Single coat
- Fast-track installation
- Reduced labour time

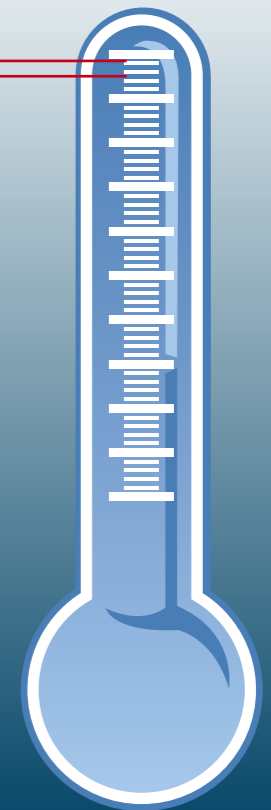

## AltroProof damp-proof membranes

The new AltroProof collection gives you the ultimate in easy-to-apply damp-proof membranes. Offering protection in up to 97% relative humidity, the AltroProof collection is ideal for fast-track installation

(over green concrete) and for refurbishment projects (on existing substrates).

### AltroProof Duo™

AltroProof Duo is a two component, solvent-free high-build epoxy resin surface damp-proof membrane. It is applied as a two coat system, providing protection for water sensitive floorcoverings. Altro resin systems, Altro vinyl and rubber floorings are universally suitable for installing directly over AltroProof Duo.

### AltroProof Solo™

AltroProof Solo is designed as a one-coat system to accommodate all types of floor finishes (vinyl, rubber and resin systems); it will provide a vapour barrier against levels of residual construction moisture to a maximum of 95% RH.



[www.altro.com](http://www.altro.com)

sample ordering

Tel: 01462 707 700 E-mail: [samples@altro.com](mailto:samples@altro.com)

product information:

Tel: 01462 707 600 E-mail: [enquiries@altro.com](mailto:enquiries@altro.com)

[samples@altro.com](mailto:samples@altro.com)

## Subfloors

### Altro acoustic underlay 1101

Altro Acoustic Underlay 1101 is suitable for use with Altro safety flooring, Altro Mondo rubber flooring and Altro smooth flooring. When tested in accordance with BS EN ISO 140-8-1998, the combined product meets the requirements of:

- Approved Document E, Resistance To The Passage of Sound, July 2003, and
- BB93 Acoustic Design of Schools (min. requirement 17dB)

For further details, contact Altro Technical Services on 01462 707600.



### Altro Everlay™ underlayment

Altro Everlay is designed to overcome the problems sometimes encountered in laying sheet floorings over new or old subfloors.

Altro Everlay can be laid over a variety of surfaces, such as old vinyl tiles, sheet metal, access floors, subfloors contaminated with oil or paint, or damp subfloors.

There are two types of Altro Everlay available, Altro Everlay A, and Altro Everlay B which has an added sound absorbent, insulating layer.

The main advantages of Altro Everlay are that it:

- provides a continuous base which is stabilised and resistant to damp
- cuts down laying time as it can reduce normal subfloor drying times

- Allows for a new, temporary floor to be laid over an existing floor, without adhesive damage on uplifting
- Affords tolerance to residual construction moisture, accommodating hygrometer readings of up to 97% RH or, on subfloors with no damp-proof membrane, of up to 92% RH.

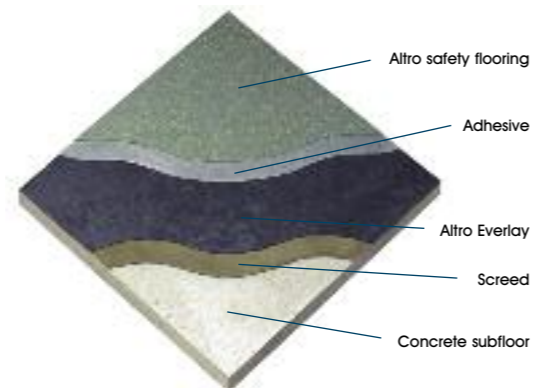

### Altro Everlay A

A specially coated fibreglass sheet underlay which is designed to enable the loose laying of Altro safety flooring, Altro rubber sheet materials, Altro Mondosport Wood and AltroSmooth Ethos. Thickness 1.2mm, width 2m, average length 50m, weight of roll 100kg.

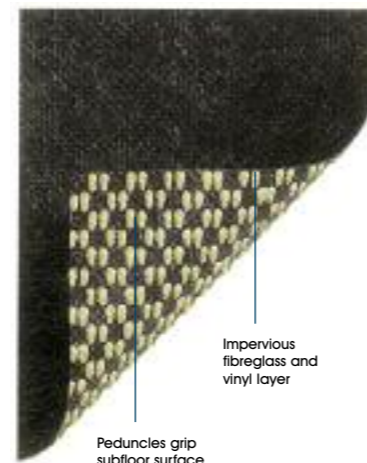

## fast track solutions / subfloors

### Typical areas where Altro Everlay may be used

- Temporary walkways or areas where substrate may need to be used later
- Screed or slabs where construction moisture has not dried out
- Areas where subfloor has been exposed to water spillage
- Old subfloors which may not contain an adequate damp-proof membrane
- On metal access floor systems (subject to flushness of joints)
- Over old, soundly fixed vinyl asbestos tiles or vinyl sheet
- To save time and cost instead of applying a surface damp-proof membrane
- On external areas where the subfloor is asphalt or damp concrete

### Altro Everlay B

A specially coated fibreglass sheet underlay incorporating a layer of resilient material, which gives the added benefit of increased insulation and sound absorption. Thickness 4mm, width 2m, average length 20m, weight of roll 88kg.

#### Altro Everlay B also has the benefits of:

- Improving the resilience of sports materials
- Giving underfoot softness and comfort to PVC sheet materials
- Improving insulation
- Improving sound absorption (20dB in accordance with ISO 140-8, when used in conjunction with Altro Sheet Material).

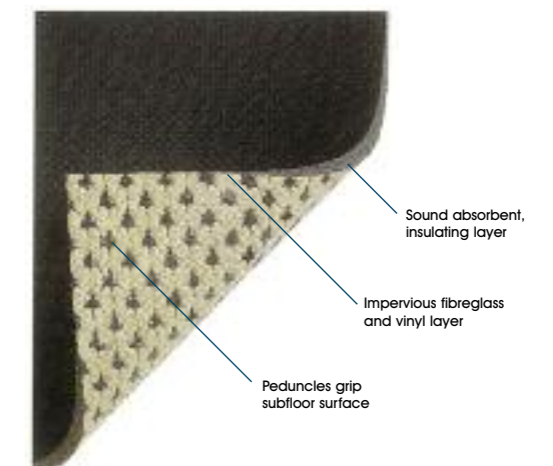

samples@altro.com

[www.altro.com](http://www.altro.com)

sample ordering

Tel: 01462 707 700 E-mail: [samples@altro.com](mailto:samples@altro.com)

product information:

Tel: 01462 707 600 E-mail: [enquiries@altro.com](mailto:enquiries@altro.com)

## Flooring accessories

### Altro adhesives

AltroFix™ 15	A single part high tack acrylic copolymer. For use with Altro safety flooring, AltroSmooth, and Altro Mondosport I, II and Wood in areas not subjected to spillage. Also for use with Altro Mondopave 2.5mm tiles and Altro Mondofutura in light traffic areas not subjected to spillage.
COVERAGE	Approximately 35-40 m <sup>2</sup> per 12 kg unit, depending on the application and subfloor porosity.
AltroFix™ 19	Two part polyurethane adhesive. After setting, this adhesive is not affected by spillage of water and most other liquids. For use with Altro safety flooring, Altro Sportflex, Altro Mondosport I and Altro Ramflex. Flooring may require weighting down. Floor must be kept clear during setting of adhesive ADH19K10B and ADH19K5B. Not suitable for vertical surfaces.
COLOUR	Neutral. Colour pigment available to special order.
COVERAGE	Average coverage 15-20 m <sup>2</sup> per 10 kg unit and 7.5-10 m <sup>2</sup> per 5 kg unit.
AltroFix™ 41	A specially formulated two part resin adhesive for use with Altro Mondopave Slate, Altro Mondofutura and Altro Mondopave 2.5mm and 4mm, in areas subject to spillages.
COVERAGE	Average coverage 12-14 m <sup>2</sup> per 5 kg unit.
AltroFix™ 365	A high tack acrylic adhesive that can be applied to dry porous and impervious surfaces. For use with Altro safety flooring, AltroSmooth, Altro Mondosport I, II and Wood, and Altro Mondoflex II in areas not subjected to spillage.
COVERAGE	Average coverage 25-35 m <sup>2</sup> per 5 litre unit depending upon subfloor and method of application.
AltroFix™ 25NF	Contact adhesive. This adhesive enables the floor to be used immediately after laying. Ensure use in well-ventilated areas. Should always be used for coving and vertical surfaces.
COLOUR	Orange
COVERAGE	Average 15 m <sup>2</sup> bonded area per 5 litre unit.

### safety flooring / recommended cleaning methods

Manual	Mechanical
<ol style="list-style-type: none"> <li>1. Sweep up loose dirt and dust</li> <li>2. Apply AltroClean 44™ or equivalent alkaline cleaner and leave for several minutes</li> <li>3. Scrub with deck scrubber or edge cleaner</li> <li>4. Mop up residue. Always use a twin compartment bucket to avoid redistribution of dirt</li> <li>5. Mop rinse with clean, warm water and allow to dry</li> </ol>	<ol style="list-style-type: none"> <li>1. Vacuum up dust and dirt, remove large debris</li> <li>2. Apply AltroClean 44™ or equivalent alkaline cleaner and leave for several minutes</li> <li>3. Machine scrub using medium synthetic pad</li> <li>4. Wet vacuum residue</li> <li>5. Rinse with warm clean water and vacuum dry</li> </ol>

Visit [www.altro.com](http://www.altro.com) for full cleaning and maintenance guidance

### Cleaners and dressings for Altro floors

AltroClean 44™	Alkaline cleaner recommended for use with Altro safety flooring.
AVAILABILITY	AltroClean 44 is sold in cases which contain either: 10 x 1l bottles or 4 x 5l bottles.
AltroClean 44+™	Concentrated alkaline cleaner recommended for use with Altro safety flooring in heavily soiled circumstances.
AVAILABILITY	AltroClean 44+ is sold in cases which contain either: 10 x 1l bottles or 4 x 5l bottles.
AltroClean 48W™	For use with Altro Mondo flooring and AltroSmooth Intrinsic, AltroSmooth Chrysalis and AltroSmooth Synthesis. AltroClean 48W can also be used with Altro safety flooring where it is not required to provide maximum slip resistance. See note below.
AVAILABILITY	AltroClean 48W is sold in cases which contain: 4 x 5l bottles.
AltroGloss 211™	For use with AltroSmooth Intrinsic and Altro Mondo flooring (excluding sports surfaces).
AVAILABILITY	AltroGloss 211 is sold in cases which contain: 4 x 5l bottles.
AltroMastic clean-up wipes	AltroMastic clean-up wipes for the removal of excess mastic before it sets.
Clean Up Solvent	For removing adhesive spillages. Clean Up Solvent is flammable and can therefore only be delivered by road transport. Note: Care must be taken when using this material as excessive use will cause surface damage to the floor covering. <b>Clean Up Solvent should not be used with any Altro floor covering containing Maxis Technology.</b>
AVAILABILITY	When ordering separately from adhesive, solvent must be in multiples of six. Please see full separate instructions available on request for maintenance of each type of flooring. Note: Altro Walkway 20 SD - avoid excessive cleaning and the use of polishes or dressings as this can adversely affect the static dissipative properties of the flooring. Note: Failure to maintain Altro safety flooring in accordance with the recommended procedure can affect the performance and slip resistance of the product. Maintenance booklets are available from Altro or your local distributor.

## Life cycle costs

### Independent analysis

For specifiers, it is important to know how much flooring and walling products will cost over their expected lifespan. This is why Altro have commissioned an independent life cycle cost analysis, conducted by BWA Facilities Consultancy. The findings give a comparison of cost relationships between different flooring and walling materials. When reviewing these costs you will also need to take into account any special circumstances affecting:

- the subfloor or subwall
- the original flooring or walling material itself
- installation
- cleaning and maintenance
- disposal
- replacement
- level of use

### Cost analysis

All of Altro's interior surfaces deliver impressive value over their lifetime.

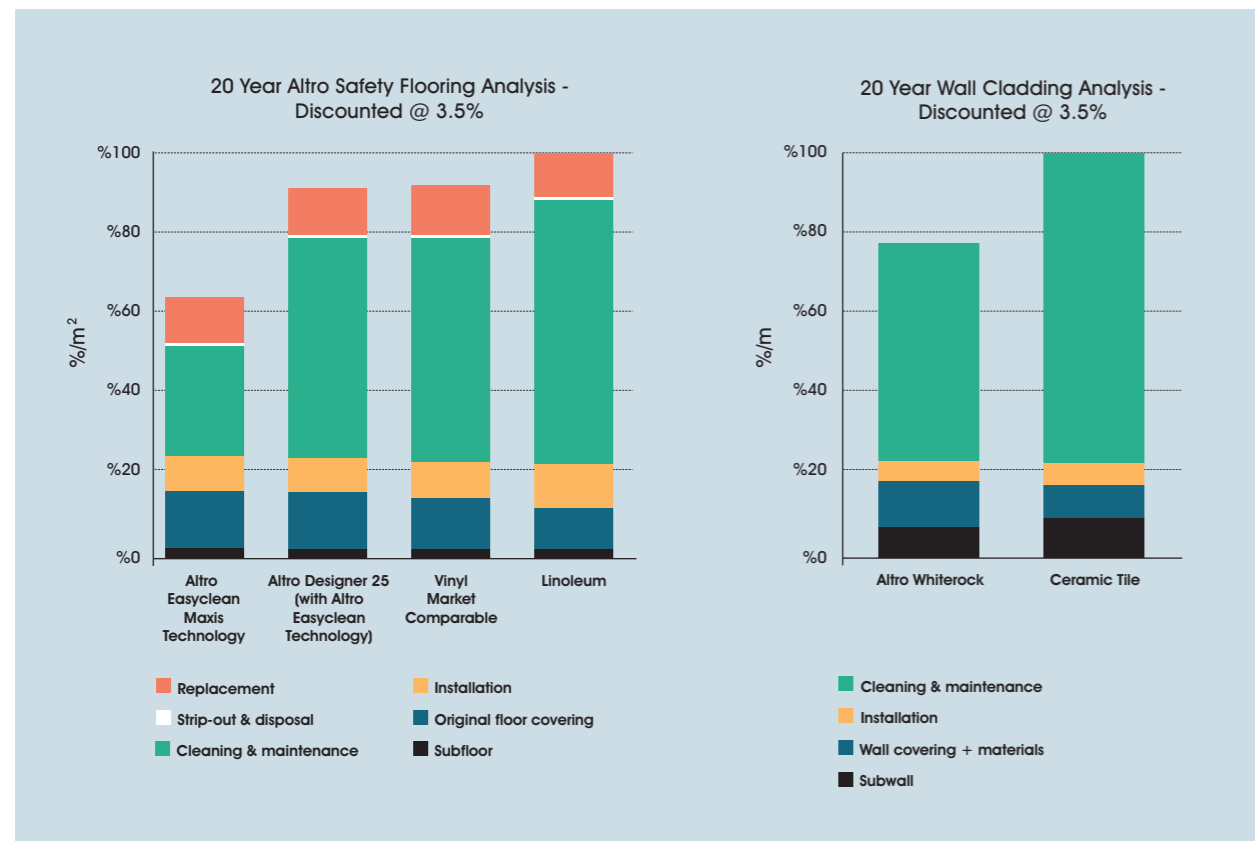

### Life cycle cost calculation

The life cycle cost analysis carried out by BWA Facilities Consultancy is based around the current Government discount rate of 3.5% (as would be utilised in a PFI/PPP type contract context\*). All original material costs were taken from trade price lists, with subfloor and installation costs obtained from Construction Industry price books. The anticipated life expectancy of the market comparable product was derived from the BMI's latest published information. Cleaning materials and labour costs were based on an assumed national average. For further details, please contact Altro.

\* The Green Book - Appraisal and Evaluation in Central Government. Treasury Guidance.

## Flooring accessories

Hand tools - primarily for use with Altro safety flooring

	Auto grooving blade 110mm		Concave heavy duty blade (box of 100)
	Auto grooving blade 120mm		High speed weld gun 110V
	Router handle No.5		High speed weld gun 220V
	Router blades (pack of 8)		Coving welding nozzle
	Groove blade u-shape (pack of 10)		High speed weld nozzle 5mm
	Grooving tool blades		Spatula
	Grooving tool handle		T20 chisel tool
	Straight heavy duty blade (box of 100)		
	Hooked heavy duty blade (box of 100)		

# Flooring accessories

## Altro PVC stair nosings and accessories

Altro PVC stair nosings and accessories are constructed in impact resistant rigid and flexible PVC, to complement the Altro Mondo rubber flooring ranges for perfectly colour co-ordinated installations. The range is also compatible with

Altro safety flooring and AltroSmooth flooring. As well as nosings and stair trim sections, accessories include matching riser and stringer sections, coved skirtings, stair and landing trims.

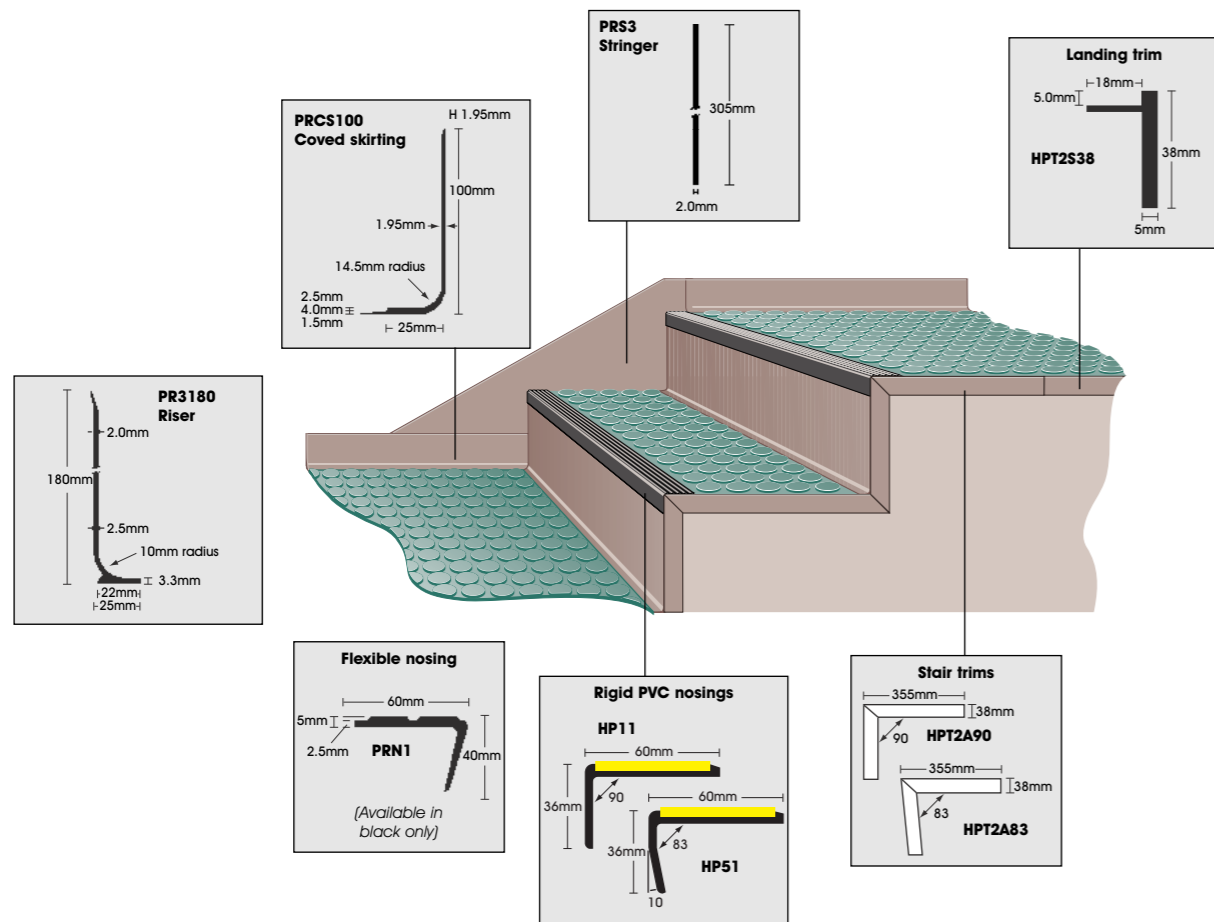

### Coved skirtings

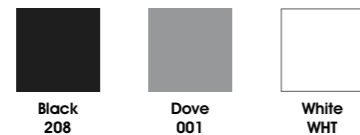

### Nosings

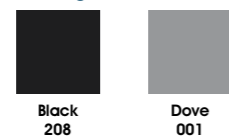

Inserts only available in yellow.

Colourways available

# Flooring adhesives guide

This guide will assist specifiers and installers with the selection of appropriate Altro recommended adhesives. Full adhesive data sheets are available on

request with Health and Safety (COSHH) guidelines. If in any doubt, please consult Altro Technical Services Department.

## Adhesives guide

	WOOD	SAND/CEMENT SCREED	LATEX SCREED	ALTRO ACOUSTIC 1101	ALTRO EVERLAY	ALTRO-PROOF DUO & SOLO	POWER FLOATING	ASPHALT	METAL	TERRAZZO	COVINGS	WALLS	POROUS SUBSTRATE	NON-POROUS SUBSTRATE
Altro safety/ (Spills)	A19	A19	A19	A19	A19	A19	A19	A19	A19	A19	A25NF	A25NF		
Altro safety/ (No Spills)	A365 or A15	A365 or A15	A365 or A15	A365 or A15	A19	A365	A365	A365	A365	A365	A25NF	A25NF		
Altro Walkway 20 SD Static Dissipative	Tremco 106	Tremco 106 or Balls F57	Tremco 106 or Balls F57	Contact Altro	Mapei G19C	Mapei G19C	Mapei G19C	Mapei G19C	Mapei G19C	Mapei G19C	A25NF			
AltroSmooth	A365 A15	A365 A15	A365 A15	A365 or A15	-	A365	A365	A365	A365	A365	A25NF	A25NF or A365		
Altro Mondopave 2.5mm and 4.0mm, Altro Mondopave Slate, Altro Mondofutura (Heavy traffic or spills)	A41	A41	A41	A41	A19 (Sheet only)	A41	A41	A41	A41	A41	A25NF			
Altro Mondopave 2.5mm, Altro Mondofutura (Light/Medium traffic, no spills)	A15	A15	A15	A15	A19 (Sheet only)	Latex Screed *	Latex Screed *	Latex Screed *	Latex Screed *	Latex Screed *	A25NF			
Altro Mondo Sportflex, Altro Mondoflex I, Altro Mondo Ramflex	A19	A19	A19	A19	A19 (Sheet only)	A19	A19	A19	A19	A19	A25NF			
Altro Mondosport I, II & Wood / Altro Mondoflex II	A365 or A15	A365 or A15	A365 or A15	A365 or A15	A19	A365	A365	A365	A365	A365	A25NF			
Altro Whiterock													W139 W157	W139

\* for adhesive recommendations, see latex screed column

N.B. Adhesives stated are direct to the subfloor. With AltroFix 365 on impervious substrates, allow complete evaporation before laying.

Altro Acoustic Underlay 1101 - The same adhesive as quoted above should be used to bond both the underlay to the subfloor and floorcovering to the underlay.



www.altro.com

sample ordering

Tel: 01462 707 700 E-mail: samples@altro.com

product information:

Tel: 01462 707 600 E-mail: enquiries@altro.com

samples@altro.com



## Self-coved with cove former & captile strip C8 to wall tiles

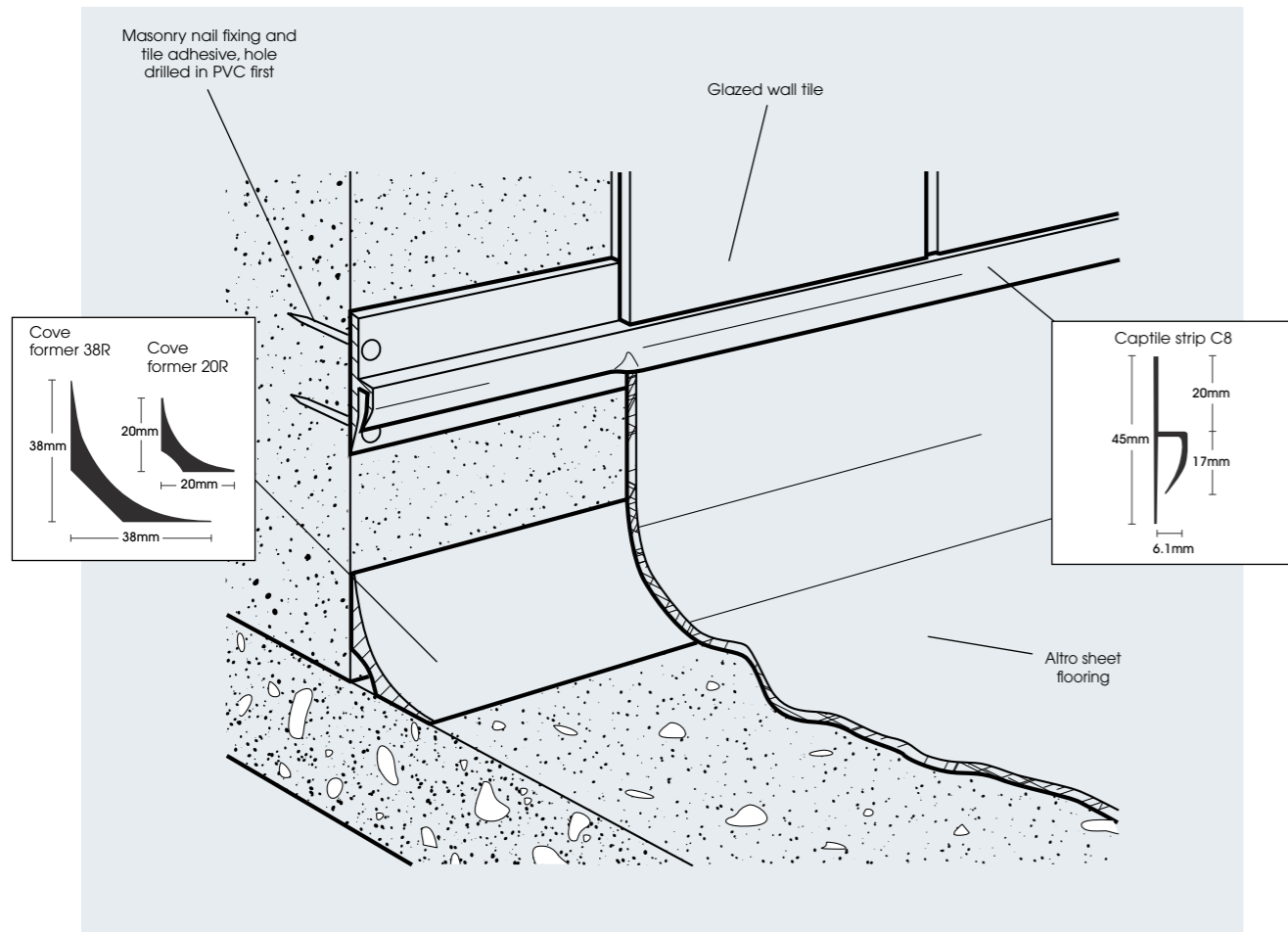

## Altro flooring and walling junctions

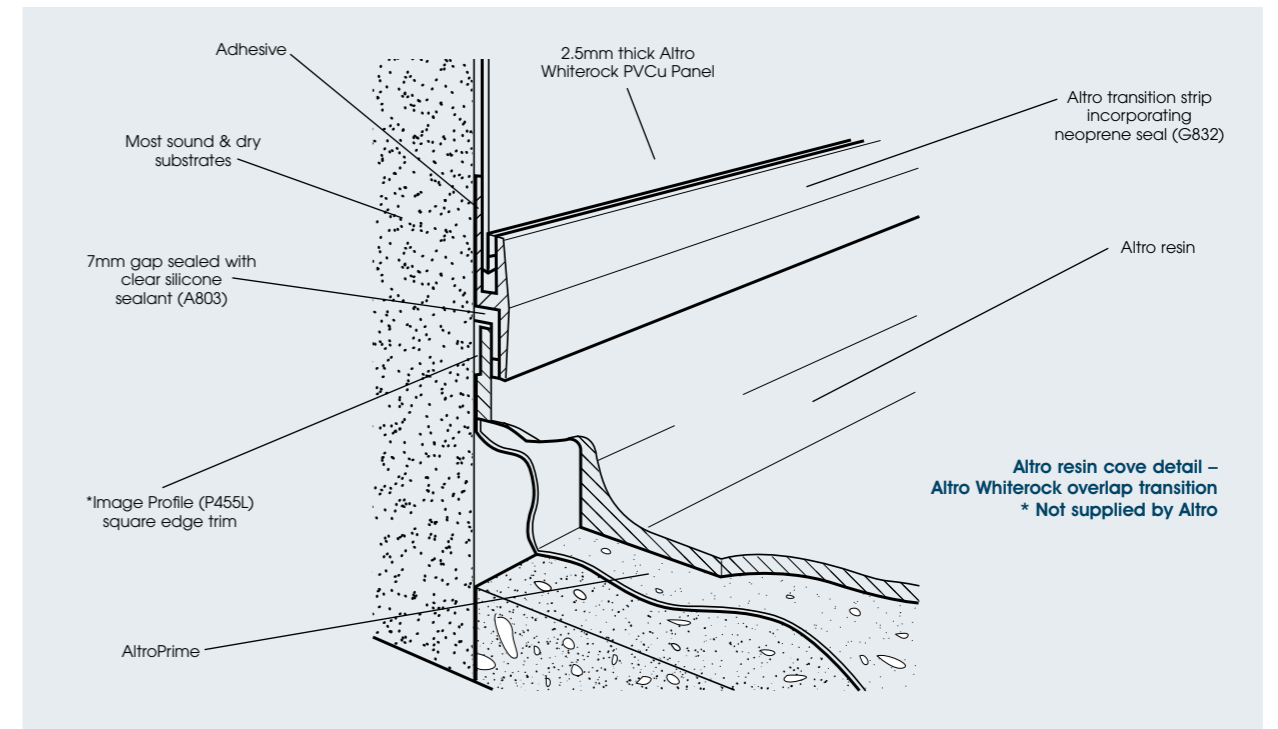

Altro resin cove detail –  
Altro Whiterock overlap transition  
\* Not supplied by Altro

## technical support / design & finishing detail

The performance of Altro flooring and walling depends on their correct installation, and the care with which jointing detail is finished. For your guidance, the drawings published here demonstrate best practice.

A representative selection of commonly encountered installations is shown. For further guidance, typical specification clauses and/or isometric diagrams please call Altro, or download from [www.altro.com](http://www.altro.com)

## Sheet flooring overlay of ceramic tiles

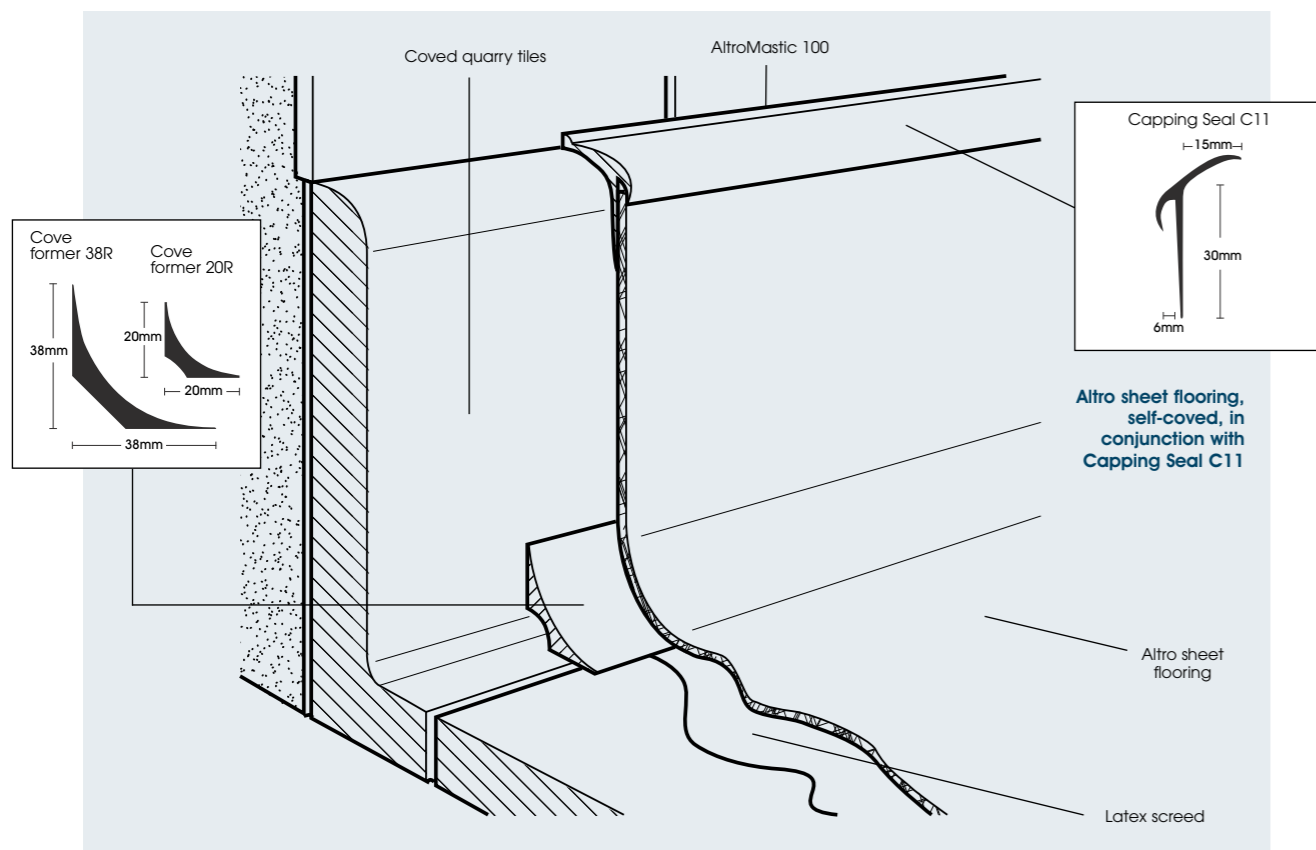

Altro sheet flooring,  
self-coved, in  
conjunction with  
Capping Seal C11

## Door architrave detail

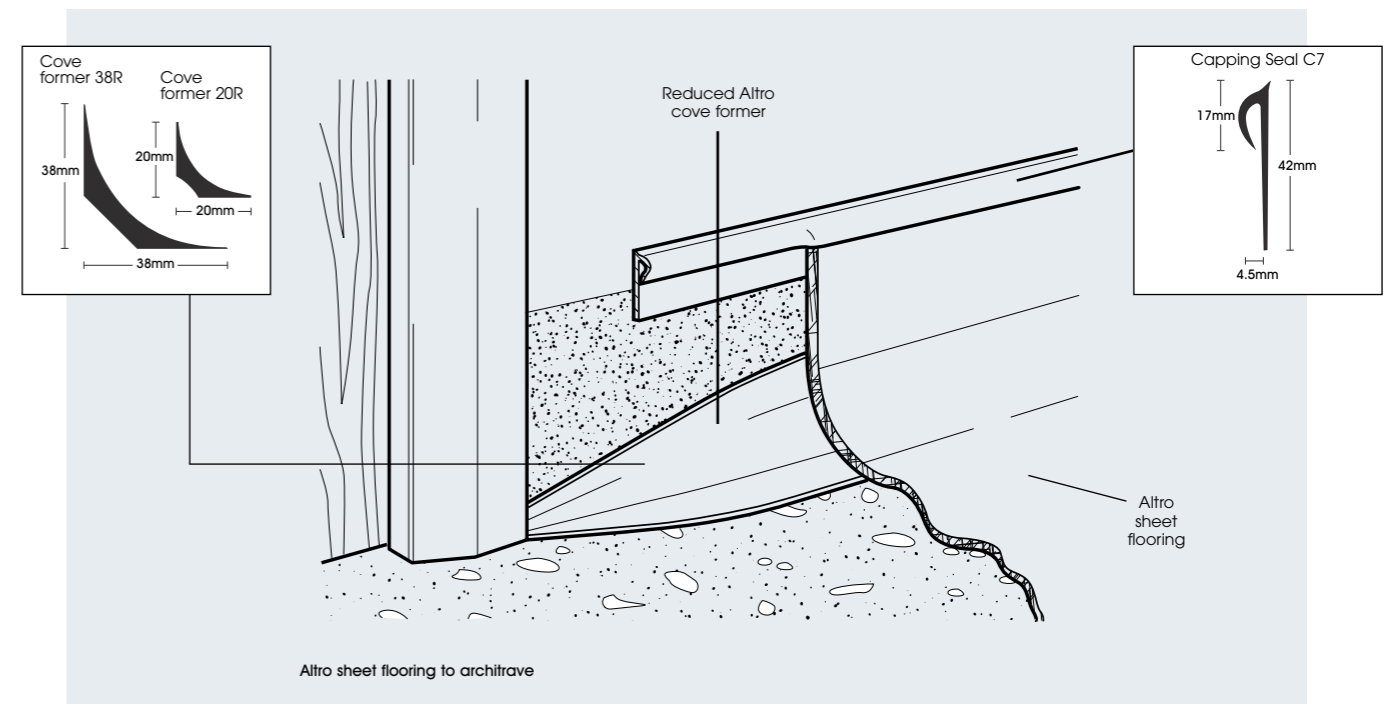

Altro sheet flooring to architrave

## Shower tray detail

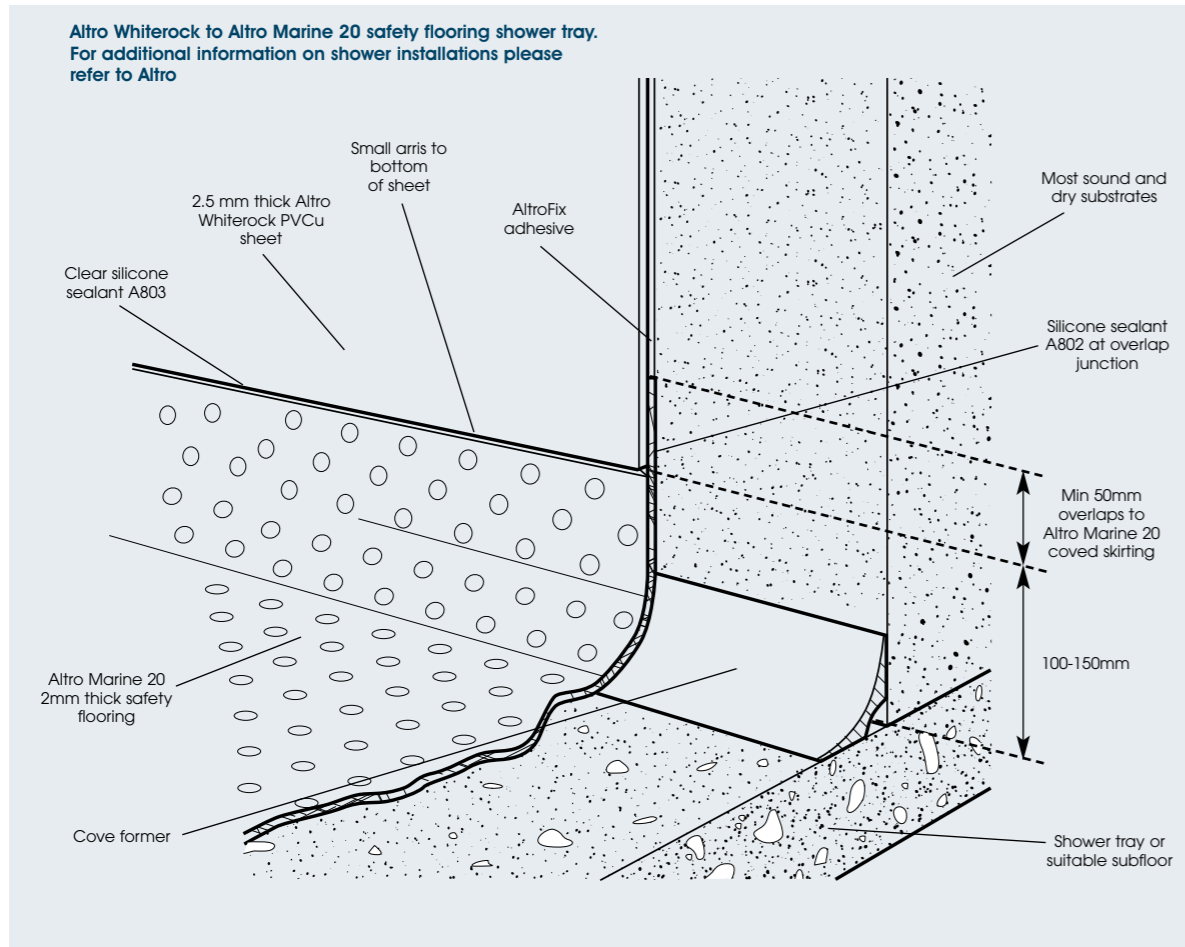

## Drain detail

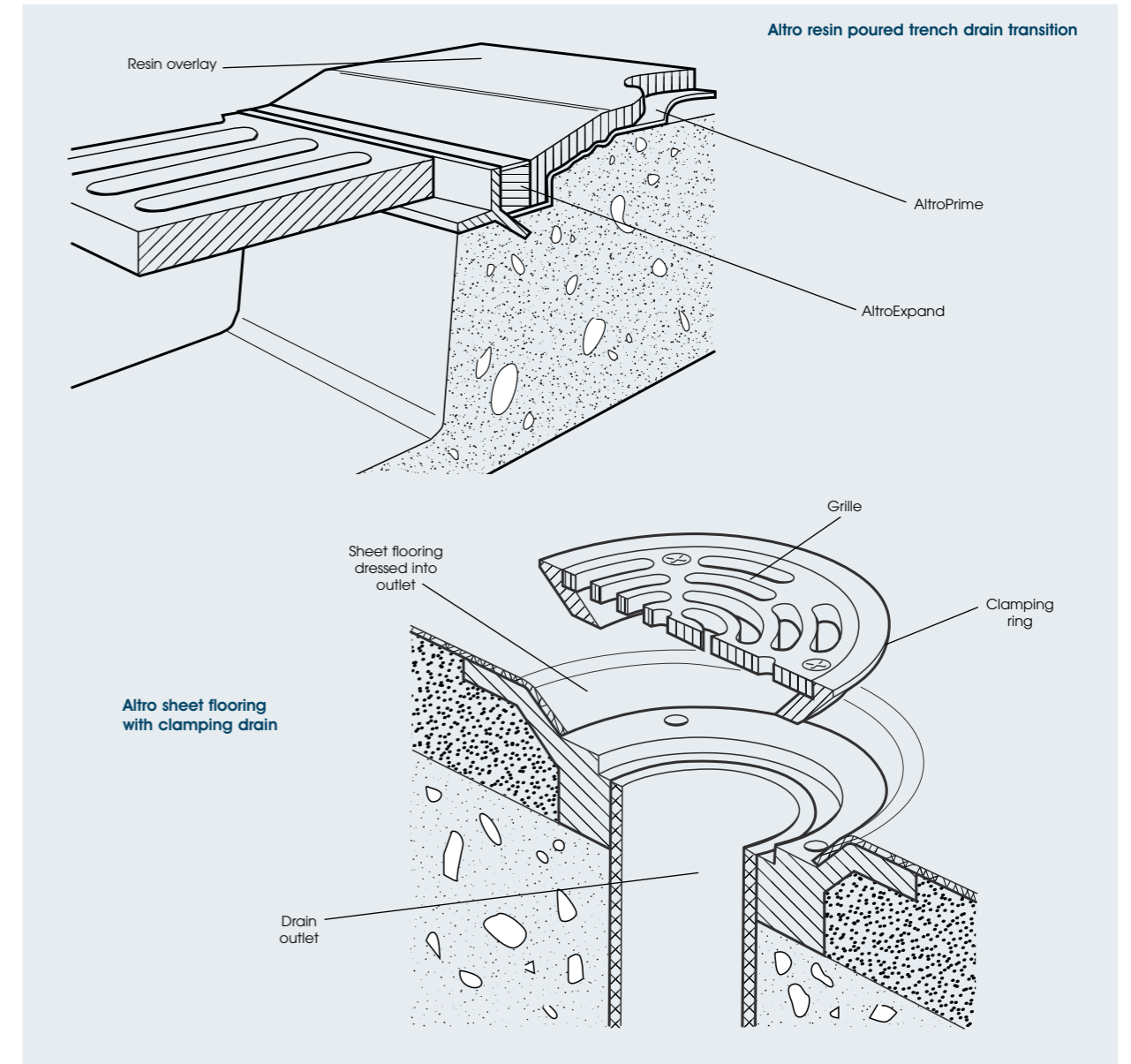

## Altro flooring and walling junctions

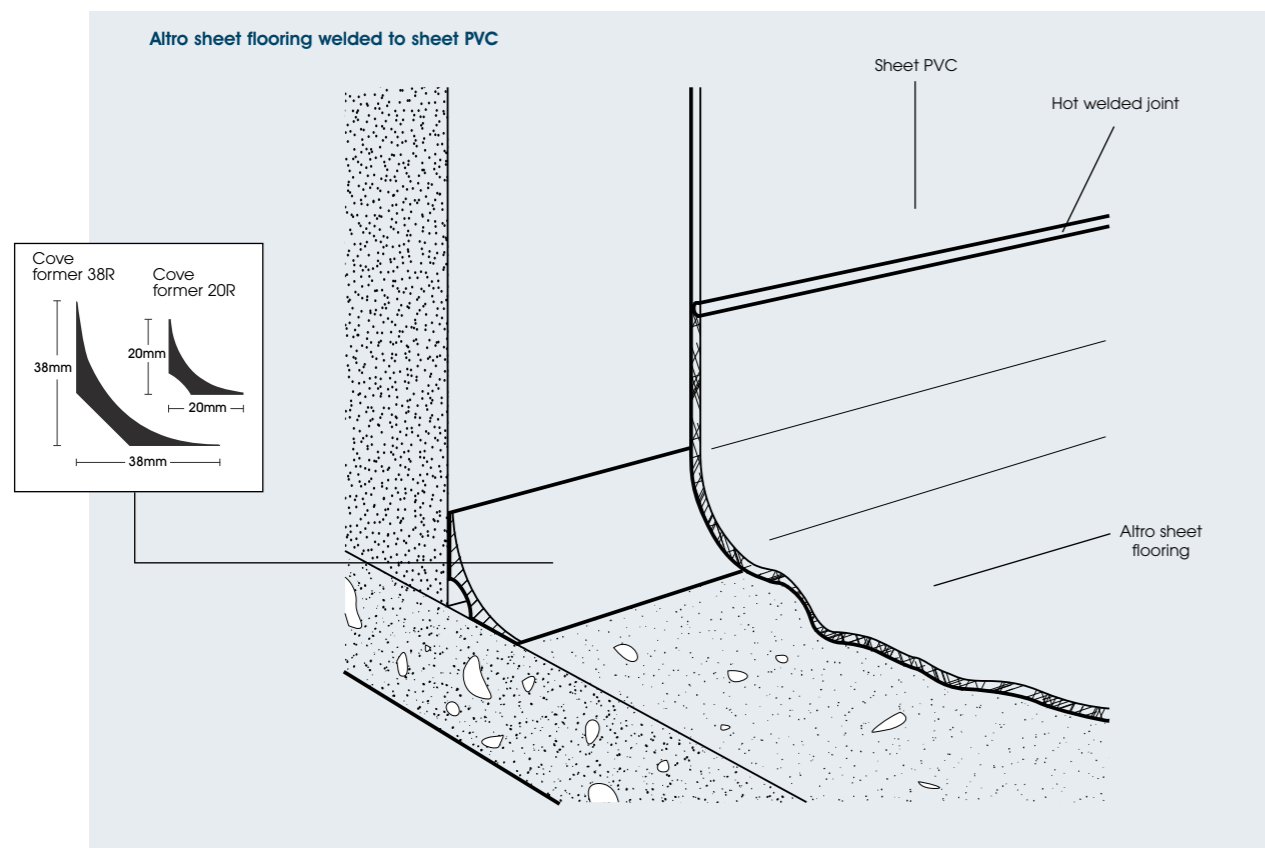

## Sheet flooring transition

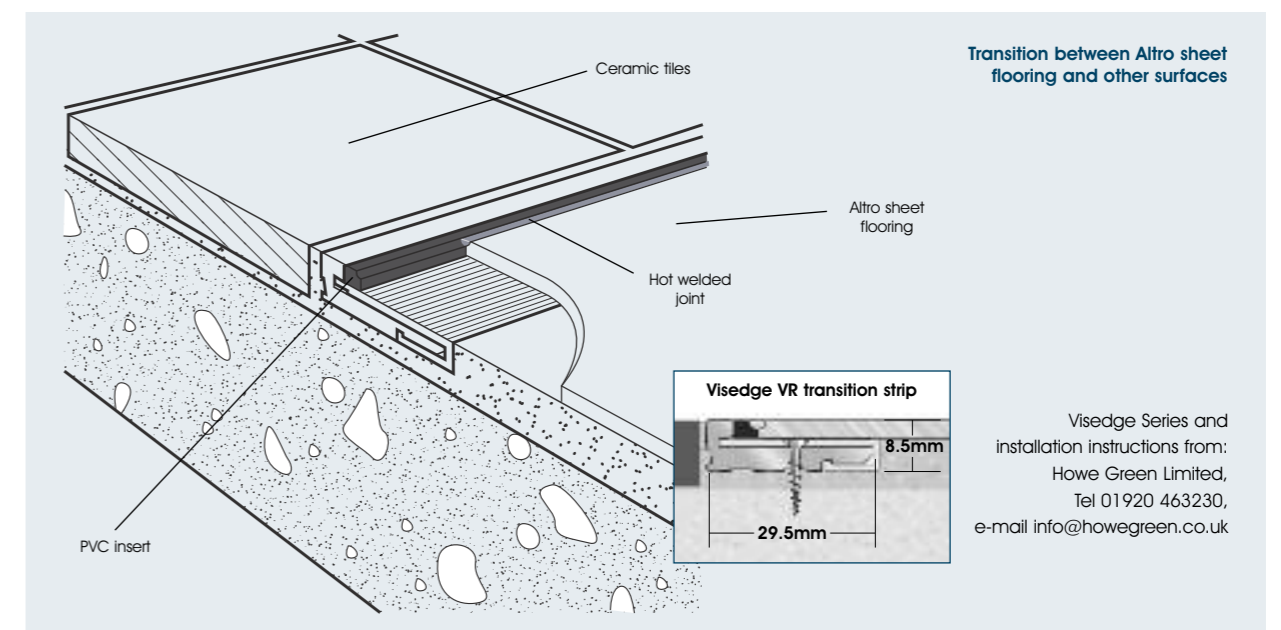

Visedge Series and installation instructions from:  
Howe Green Limited,  
Tel 01920 463230,  
e-mail info@howegreen.co.uk



## Resin flooring

Altro resin overlayment transition joint detail

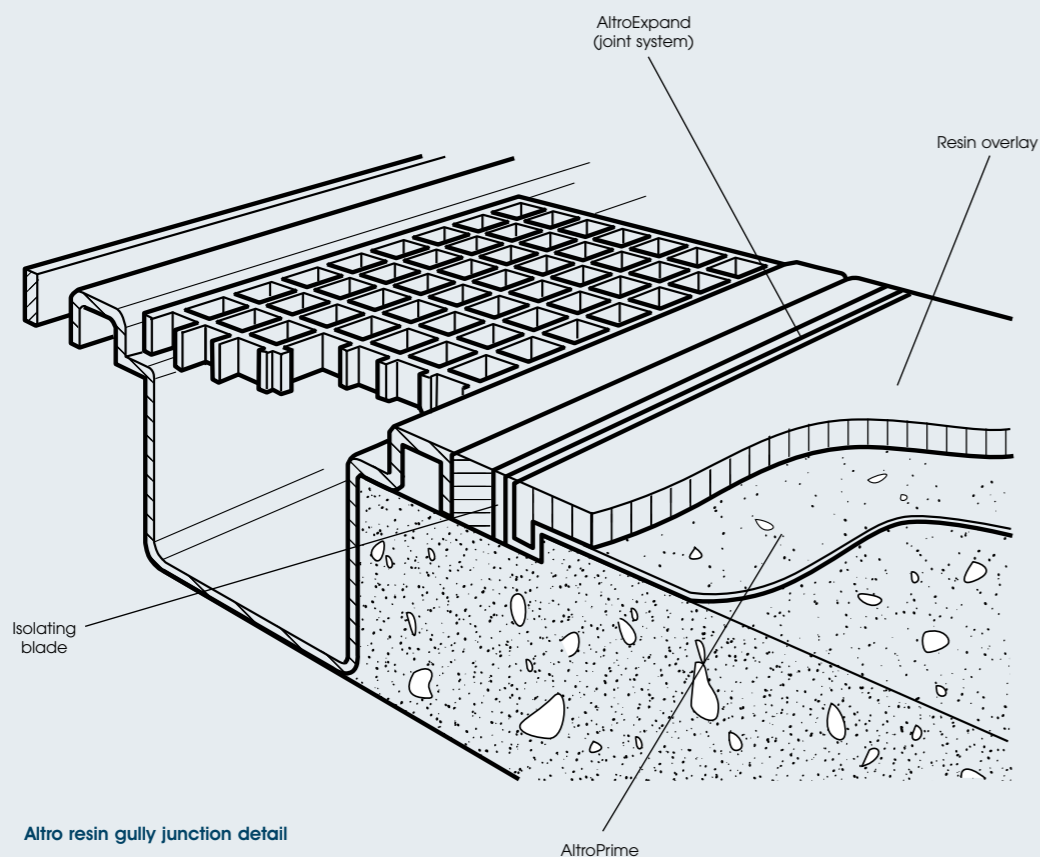
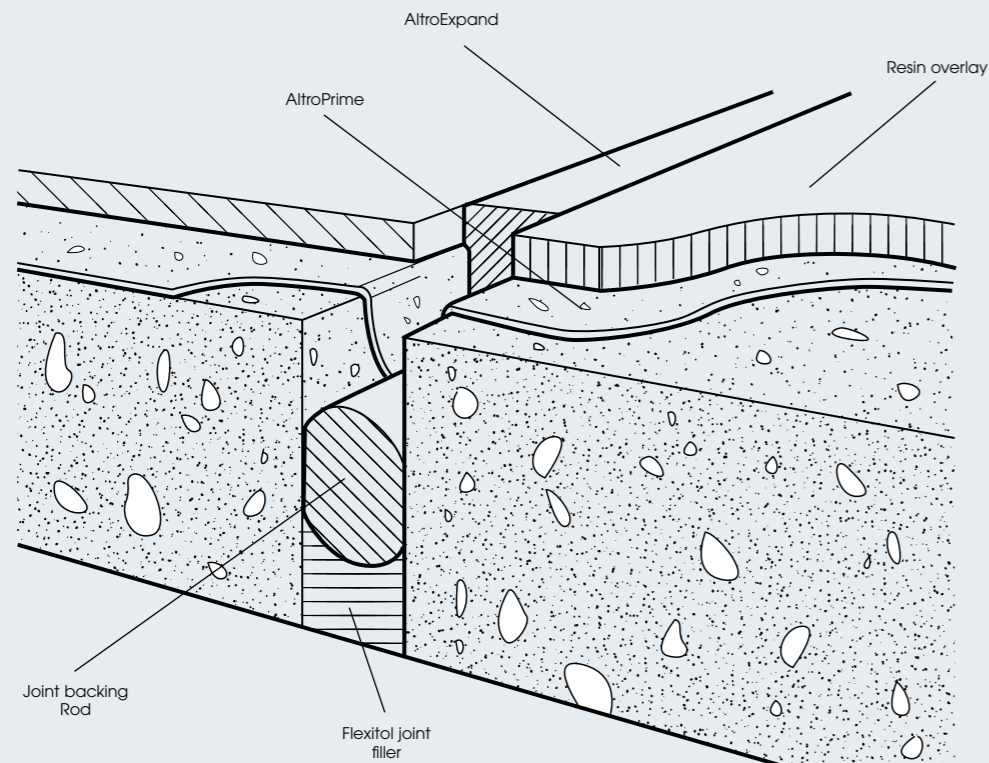

Altro resin gully junction detail

Altro offer many other installation detail drawings to assist specifiers and installers. We have listed below a few of the drawings available. All our installation detail drawings can be downloaded from [www.altro.com](http://www.altro.com), within the 'Technical Information' section of the site. Altro can also provide detail and typical specification clauses for virtually any installation of our flooring, walling, doors or ceiling products. Please contact us on 01462 707600.

### Floor/wall joint and coving

- Altro sheet flooring, straight laid flush to wall
- Altro sheet flooring, sit-on cove
- Altro sheet flooring, set-in cove skirting
- Altro sheet flooring, self-coved to painted wall finish, with Capping Seal C7
- Altro sheet flooring, self-coved to ceramic tiles, with Captile Strip C8
- Altro sheet flooring, self-coved over covered ceramic tiles, with Capping Seal C11
- Altro sheet flooring, self-coved and welded to flexible sheet PVCu wall covering
- Altro sheet flooring, self-coved to Altro Whiterock hygienic PVCu cladding
- Altro resin flooring cove detail, coatings flows and seals
- Altro resin flooring cove detail, isolated slab to wall
- Altro resin flooring cove detail, screed
- Altro resin flooring cove detail, Altro Whiterock hygienic PVCu cladding overlap transition (floor installed first)
- Altro resin flooring cove detail, Altro Whiterock hygienic PVCu cladding transition (wall installed first)
- Altro Whiterock hygienic PVCu cladding, to quarry tile floor

### Shower trays

- Altro Whiterock hygienic PVCu cladding to Altro Marine 20 safety flooring shower tray
- For further information on shower installations please contact Altro Technical Services on 01462 707600.

All our installation detail drawings can be viewed/downloaded from our website [www.altro.com](http://www.altro.com), within the 'Technical Information' section.

## Doors and abutments

- Altro sheet flooring to architrave
- Altro Whiterock hygienic PVCu cladding to architrave
- Altro Whiterock hygienic PVCu cladding to window/door frame
- Altro Whiterock hygienic PVCu cladding boxing/inspection cover detail
- Altro Whiterock hygienic PVCu cladding, making up above glazed tiles

### Floor transition edging and drains/access

- Altro sheet flooring, finished with gully angle GA25/GA35
- Altro sheet flooring, finished with gully edge GE25RE/GE35RE
- Altro sheet flooring, with clamping drain
- Altro sheet flooring, with clamping channel
- Altro sheet flooring, with access cover
- Altro sheet flooring, with Visedge strip transition between other surfaces
- Altro resin flooring, poured trench drain transition
- Altro resin flooring, overlayment transition joint detail
- Altro resin flooring, gully junction detail

### Stairs detailing

- Altro Mondo rubber flooring, with plastic stair accessories
- Altro sheet flooring, with aluminium stair accessories

### Walls detailing

- Altro Whiterock hygienic PVCu cladding horizontal wall joint, installations over 3m from floor
- Altro Whiterock junction to stainless steel
- Altro Whiterock hygienic PVCu cladding or stainless steel corner protection fixing
- Stainless steel cladding to stainless steel capping

### Ceilings

- Altro Whiterock hygienic PVCu cladding, access hatch detail
- Altro Whiterock hygienic PVCu cladding, diffuser panel detail

## Wall systems

### Altro offer you a complete shower solution

Altro offer you a complete flooring, walling and ceiling solution for showers, where cleanability, hygiene, waterproof sealing and safety are of the highest importance.

Altro Whiterock PVCu cladding systems, combined with Altro Marine 20 safety flooring, deliver an imperviously 'tanked' solution with integrated drainage and covered wall joints.

The system provides:

- safety underfoot
- high durability
- impervious floor and wall surfaces (grout free)
- coved floor to wall joints
- surfaces that contain integral bacteriostat
- a range of floor and wall colours
- co-ordinating flooring for changing areas



David Lloyd Leisure Centre

### Seven good reasons to choose Altro Whiterock

Altro Whiterock semi-rigid hygienic PVCu wall cladding offers many advantages over ceramic tiles:

- lower installed costs
- better impact resistance
- hygienic, impervious jointing
- welded joint for even higher levels of hygiene
- better appearance retention
- improved cleanability
- quicker installation



Ennerdale Leisure

Altro Marine 20 safety flooring - refer to page 40  
 Altro Whiterock cladding systems - refer to pages 110-127

## Wall finishes

A variety of wall finishes may be used in conjunction with Altro Marine 20 safety flooring within showers.

### Altro Whiterock PVCu hygienic wall and ceiling cladding

Altro Whiterock PVCu hygienic wall and ceiling cladding is grout-free, is thermoformed around corners and all joints are sealed, creating an impervious, easy to clean finish from floor to ceiling.

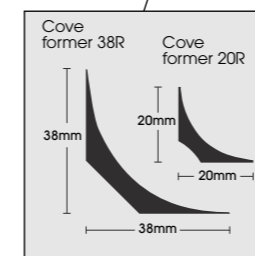
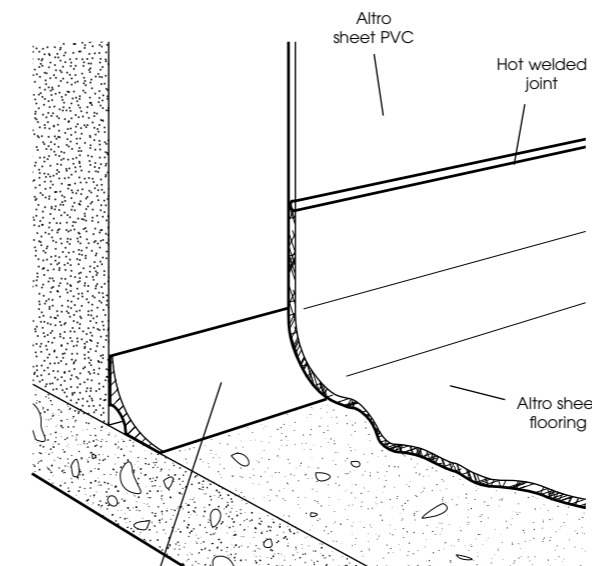
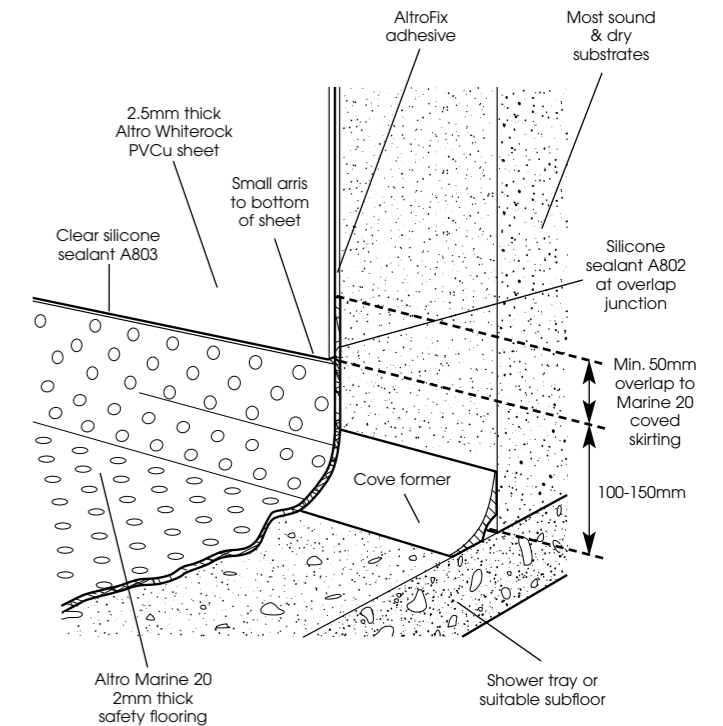

### AltroSmooth sheet vinyl

AltroSmooth sheet vinyl may also be hot welded to the floor finish to create a waterproof joint. AltroSmooth can be wrapped around corners and coved to the ceiling.

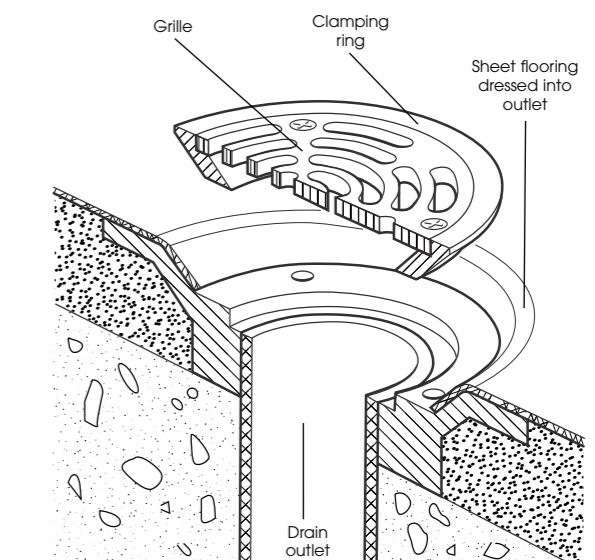

### Detailing - drain outlet

A 'clamping' drain outlet can be used, creating a hygienic and waterproof installation.

All our installation detail drawings can be viewed/downloaded from our website [www.altro.com](http://www.altro.com), within the 'Technical Information' section.

## Customer support / CPD services

### Prevention is better than cure

Defect-free construction is a major industry preoccupation. This seminar looks at the principal causes of failure and how to get your product selection and installation right first time.

Duration: 1 hour.

### High impact, hygienic wall finishes

The CPD covers the thought processes behind the use of Altro's range of performance, high design, walling products.

Starting with an outline of the needs of the current marketplace covering regulations & specification considerations, into image creation and hygiene and safety.

Duration: 1 hour.

### Resin - where function meets design

From machine shops to warehouses, resin systems are providing the performance required to keep the wheels of industry rolling. But what type of resin should you use? Will it resist chemicals and be easy to clean? You'll find the answers to these and other questions by attending this seminar.

Duration: 1 hour.

### A question of sports floors

Provides an overview of the performance criteria in sporting locations and the types of flooring most suited to meet those needs.

Duration: 1 hour.

### Developing a safer environment - Sustainability

This seminar describes the steps and processes towards sustainability in the built environment, introduces the Government's strategy for sustainable construction and discusses the benefits of PVC.

Duration: 1 hour.

### How to reduce risk of slipping

According to the Health & Safety Executive, slips and trips are responsible for 33% of all reported major injuries and cost the economy a staggering £512 million each year. The specification of appropriate flooring is an important way of controlling risk.

To coincide with the HSE's campaign to reduce slips by education and enforcement, this seminar covers:

- the scale of the problem
- good design practice & HSE recommendations
- legal obligations and new guidelines
- a model for risk assessment
- product selection, testing and standards
- complies with RIBA Core CPD Curriculum

Duration: 1 hour.

### The learning curve in education

Solutions for every education building including universities, laboratories, primary, secondary schools and nurseries.

Provides an overview of the types of flooring and walling solutions available for all areas - from general circulation to sports halls, special needs to dining halls, toilets to class rooms.

Duration: 1 hour.

### Colour & Contrast

Introducing colour and contrast requirements for access and safe usage of public buildings.

- Simplifying the legislation surrounding colour and contrast including: The Disability Discrimination Act (DDA), BS8300 2009 and Approved Document M (with reference to Project Rainbow, research by Dr Geoff Cook of Reading University)
- How good use of colour and contrast can aid navigation
- How to provide good contrast - colour schemes to meet the current recommended standards
- Definition of LRV and measurement of colour and luminance contrast

Duration: 1 hour.

Available as RIBA Online CPD: <http://onlinecpd.ribaenterprises.com>  
or please contact us for further details or to book your place:  
Tel: 01462 707604 Fax: 01462 707504 e-mail: [cpd@altro.com](mailto:cpd@altro.com)



## Altro specifications

### Altro safety flooring, Altro rubber flooring, Altro Mondo sports flooring

NBS Plus model specification guides for Altro safety flooring, Altro rubber flooring and Altro Mondo Sports flooring are available in an NBS format from Altro - as hard copy, on disk or on [www.altro.com](http://www.altro.com)

Those offer full guidance on completion of all aspects of a successful floor installation, from base preparation and underlays to jointing and coving. For guidance to typical format, an abbreviated specification is shown below\*:

### Resin flooring

NBS Plus model specification guides for M12 resin flooring are available in an NBS format from Altro, as hard copy, on disk or on [www.altro.com](http://www.altro.com).

Altro will also be pleased to produce written specifications for its range of resin flooring upon request. Contact 01462 707600 for information.

### Walling

NBS style specifications for Altro Whiterock walling and ceiling systems are also available. Please request a copy on 01462 707600.

## Altro specifications

SG	1041-02	ALTRO SAFETY VINYL	680	A	SEAM WELDING*:
150	A	PLASTICS FLOORING:	731	A	SEALANT*:
		• Location: .....	741	A	EDGING TO: .....
		• Base: .....	741	B	EDGING TO: .....
		Preparation: .....	750	A	STAIR NOSINGS*:
		• Fabricated underlay: .....	751	A	STAIR TRIM*:
		as clause: .....	751	B	LANDING TRIM*:
		• Flooring roll: Homogeneous/Heterogeneous PVC	761	A	STAIR COVERINGS*:
		to BS EN 649/BS EN 13845.	770	A	SET-IN COVED SKIRTINGS*:
		Manufacturer and reference: Altro .....	770	B	SIT-ON COVED SKIRTINGS*:
		safety floor by Altro,	771	A	SELF-COVED SKIRTINGS*:
		telephone 01462 707600, fax 01462 707610.	773	A	JUNCTIONS BETWEEN
		BS EN 685 class 43.			SELF-COVED SKIRTINGS AND
		Width: 2000 mm			DOOR FRAMES/ARCHITRAVE*:
		Thickness: ..... mm	775	A	STAIR STRINGER*:
		Colour: .....	780	A	TRAFFIC*:
		• Adhesive (and primer if recommended by	821	A	FINISHING PLASTICS FLOORING*:
		manufacturer): .....	821	B	FINISHING PLASTICS FLOORING*:
		• Seam welding: Hot-welding with matching			
		Altro Welding Rod, as clause 680A.			
		• Accessories: .....			
		• Finishing: .....			
		• Special requirements: .....			
462	A	SMOOTHING UNDERLAYMENT COMPOUND*:			
531	A	SURFACE DAMP PROOF MEMBRANE*:			
541	A	SHEET UNDERLAY*:			
641	A	ADHESIVE FIXING - ALTRO SHEET FLOORING*:			

\* (see full Altro NBS Guides SG1041-02 - Safety Flooring; SG1042-02 - Rubber Flooring; SG 1101-02 - Sports Flooring for reference with full details).



## Case Studies

### Altro Timbersafe™ II



#### **Cumbernauld College**

“The new Altro flooring creates a warm and welcoming environment within the salon. The walnut wood-effect finish looks great, and provides a durable and safe surface for staff, students and visitors.”

**Martin Loy, Cumbernauld College**

### AltroCrete™ PU Excel



#### **Newfield School**

“The interior surfaces from Altro look superb and will help us to provide students with the best possible learning environment throughout their time with us.”

**Chris Fox, Business Manager at Newfield School**